

**NICHIA CORPORATION**

## **SPECIFICATIONS FOR WARM WHITE LED**

### **NVSL219CT**

- Pb-free Reflow Soldering Application
- Built-in ESD Protection Device
- RoHS Compliant



## SPECIFICATIONS

### (1) Absolute Maximum Ratings

| Item                      | Symbol    | Absolute Maximum Rating | Unit |
|---------------------------|-----------|-------------------------|------|
| Forward Current           | $I_F$     | 1800                    | mA   |
| Pulse Forward Current     | $I_{FP}$  | 2400                    | mA   |
| Allowable Reverse Current | $I_R$     | 85                      | mA   |
| Power Dissipation         | $P_D$     | 5.94                    | W    |
| Operating Temperature     | $T_{opr}$ | -40~100                 | °C   |
| Storage Temperature       | $T_{stg}$ | -40~100                 | °C   |
| Junction Temperature      | $T_J$     | 150                     | °C   |

\* Absolute Maximum Ratings at  $T_S=25^\circ\text{C}$ .

\*  $I_{FP}$  conditions with pulse width  $\leq 10\text{ms}$  and duty cycle  $\leq 10\%$ .

### (2) Initial Electrical/Optical Characteristics

| Item               |                         | Symbol          | Condition          | Typ                | Max                | Unit   |    |
|--------------------|-------------------------|-----------------|--------------------|--------------------|--------------------|--------|----|
| Forward Voltage    |                         | $V_F$           | $I_F=700\text{mA}$ | 2.98               | -                  | V      |    |
|                    |                         |                 | $I_F=350\text{mA}$ | 2.83               | -                  |        |    |
| R70                | Luminous Flux           |                 | $\Phi_v$           | $I_F=700\text{mA}$ | 320                | -      | lm |
|                    |                         |                 |                    | $I_F=350\text{mA}$ | 172                | -      |    |
|                    | Luminous Intensity      |                 | $I_v$              | $I_F=700\text{mA}$ | 91                 | -      | cd |
|                    |                         |                 |                    | $I_F=350\text{mA}$ | 60                 | -      |    |
|                    | Color Rendering Index   |                 | $R_a$              | $I_F=700\text{mA}$ | 73                 | -      | -  |
|                    | Chromaticity Coordinate |                 | x                  | -                  | $I_F=700\text{mA}$ | 0.3818 | -  |
| y                  |                         |                 |                    |                    | $I_F=700\text{mA}$ | 0.3797 | -  |
| R8000              | Luminous Flux           |                 | $\Phi_v$           | $I_F=700\text{mA}$ | 297                | -      | lm |
|                    |                         |                 |                    | $I_F=350\text{mA}$ | 158                | -      |    |
|                    | Luminous Intensity      |                 | $I_v$              | $I_F=700\text{mA}$ | 88                 | -      | cd |
|                    |                         |                 |                    | $I_F=350\text{mA}$ | 58                 | -      |    |
|                    | Color Rendering Index   |                 | $R_a$              | $I_F=700\text{mA}$ | 83                 | -      | -  |
|                    | Chromaticity Coordinate |                 | x                  | -                  | $I_F=700\text{mA}$ | 0.4073 | -  |
| y                  |                         |                 |                    |                    | $I_F=700\text{mA}$ | 0.3917 | -  |
| R9050              | Luminous Flux           |                 | $\Phi_v$           | $I_F=700\text{mA}$ | 236                | -      | lm |
|                    |                         |                 |                    | $I_F=350\text{mA}$ | 126                | -      |    |
|                    | Luminous Intensity      |                 | $I_v$              | $I_F=700\text{mA}$ | 72                 | -      | cd |
|                    |                         |                 |                    | $I_F=350\text{mA}$ | 39                 | -      |    |
|                    | Color Rendering Index   |                 | $R_a$              | $I_F=700\text{mA}$ | 93                 | -      | -  |
|                    | Chromaticity Coordinate |                 | x                  | -                  | $I_F=700\text{mA}$ | 0.4073 | -  |
| y                  |                         |                 |                    |                    | $I_F=700\text{mA}$ | 0.3917 | -  |
| Thermal Resistance |                         | $R_{\theta JS}$ | -                  | 4.2                | 6.4                | °C/W   |    |

\* Characteristics at  $T_S=25^\circ\text{C}$ .

\* Luminous Flux value as per CIE 127:2007 standard.

\* Chromaticity Coordinates as per CIE 1931 Chromaticity Chart.

\*  $R_{\theta JS}$  is the thermal resistance from the junction to the  $T_S$  measurement point.

# RANKS

| Item                  | Rank  | Condition             | Min | Max | Unit |
|-----------------------|-------|-----------------------|-----|-----|------|
| Forward Voltage       | M1    | I <sub>F</sub> =700mA | 3.1 | 3.3 | V    |
|                       | L2    |                       | 2.9 | 3.1 |      |
|                       | L1    |                       | 2.7 | 2.9 |      |
| Luminous Flux         | D340  | I <sub>F</sub> =700mA | 340 | 360 | lm   |
|                       | D320  |                       | 320 | 340 |      |
|                       | D300  |                       | 300 | 320 |      |
|                       | D280  |                       | 280 | 300 |      |
|                       | D260  |                       | 260 | 280 |      |
|                       | D240  |                       | 240 | 260 |      |
|                       | D220  |                       | 220 | 240 |      |
|                       | D200  |                       | 200 | 220 |      |
| Color Rendering Index | R70   | R <sub>a</sub>        | 70  | -   | -    |
|                       |       | R <sub>9</sub>        | 80  | -   |      |
|                       | R8000 | R <sub>a</sub>        | 0   | -   |      |
|                       |       | R <sub>9</sub>        | 90  | -   |      |
|                       | R9050 | R <sub>9</sub>        | 50  | -   |      |

## Color Ranks

The color ranks have chromaticity ranges within 3-step MacAdam ellipse.

|                        |   | Rank<br>sm273 | Rank<br>sm303 | Rank<br>sm353 | Rank<br>sm403 | Rank<br>sm453 |
|------------------------|---|---------------|---------------|---------------|---------------|---------------|
| Center Point           | x | 0.4578        | 0.4338        | 0.4073        | 0.3818        | 0.3611        |
|                        | y | 0.4101        | 0.4030        | 0.3917        | 0.3797        | 0.3658        |
| Minor Axis             | a | 0.004056      | 0.004107      | 0.004098      | 0.004071      | 0.003852      |
| Major Axis             | b | 0.007872      | 0.008391      | 0.008796      | 0.009282      | 0.009009      |
| Ellipse Rotation Angle | Φ | -36.05        | -36.00        | -35.47        | -35.95        | -34.33        |

The color ranks have chromaticity ranges within 5-step MacAdam ellipse.

|                        |   | Rank<br>sm2750a | Rank<br>sm2750b | Rank<br>sm2750c | Rank<br>sm2750d | Rank<br>sm2750e | Rank<br>sm2750f |
|------------------------|---|-----------------|-----------------|-----------------|-----------------|-----------------|-----------------|
| Center Point           | x | 0.4578          |                 |                 |                 |                 |                 |
|                        | y | 0.4101          |                 |                 |                 |                 |                 |
| Minor Axis             | a | 0.006760        |                 |                 |                 |                 |                 |
| Major Axis             | b | 0.013120        |                 |                 |                 |                 |                 |
| Ellipse Rotation Angle | Φ | -36.05          |                 |                 |                 |                 |                 |

|                        |   | Rank<br>sm3050a | Rank<br>sm3050b | Rank<br>sm3050c | Rank<br>sm3050d | Rank<br>sm3050e | Rank<br>sm3050f |
|------------------------|---|-----------------|-----------------|-----------------|-----------------|-----------------|-----------------|
| Center Point           | x | 0.4338          |                 |                 |                 |                 |                 |
|                        | y | 0.4030          |                 |                 |                 |                 |                 |
| Minor Axis             | a | 0.006845        |                 |                 |                 |                 |                 |
| Major Axis             | b | 0.013985        |                 |                 |                 |                 |                 |
| Ellipse Rotation Angle | Φ | -36.00          |                 |                 |                 |                 |                 |

|                        |        | Rank<br>sm3550a | Rank<br>sm3550b | Rank<br>sm3550c | Rank<br>sm3550d | Rank<br>sm3550e | Rank<br>sm3550f |
|------------------------|--------|-----------------|-----------------|-----------------|-----------------|-----------------|-----------------|
| Center Point           | x      | 0.4073          |                 |                 |                 |                 |                 |
|                        | y      | 0.3917          |                 |                 |                 |                 |                 |
| Minor Axis             | a      | 0.006830        |                 |                 |                 |                 |                 |
| Major Axis             | b      | 0.014660        |                 |                 |                 |                 |                 |
| Ellipse Rotation Angle | $\Phi$ | -35.47          |                 |                 |                 |                 |                 |

|                        |        | Rank<br>sm4050a | Rank<br>sm4050b | Rank<br>sm4050c | Rank<br>sm4050d | Rank<br>sm4050e | Rank<br>sm4050f |
|------------------------|--------|-----------------|-----------------|-----------------|-----------------|-----------------|-----------------|
| Center Point           | x      | 0.3818          |                 |                 |                 |                 |                 |
|                        | y      | 0.3797          |                 |                 |                 |                 |                 |
| Minor Axis             | a      | 0.006785        |                 |                 |                 |                 |                 |
| Major Axis             | b      | 0.015470        |                 |                 |                 |                 |                 |
| Ellipse Rotation Angle | $\Phi$ | -35.95          |                 |                 |                 |                 |                 |

|                        |        | Rank<br>sm4550a | Rank<br>sm4550b | Rank<br>sm4550c | Rank<br>sm4550d | Rank<br>sm4550e | Rank<br>sm4550f |
|------------------------|--------|-----------------|-----------------|-----------------|-----------------|-----------------|-----------------|
| Center Point           | x      | 0.3611          |                 |                 |                 |                 |                 |
|                        | y      | 0.3658          |                 |                 |                 |                 |                 |
| Minor Axis             | a      | 0.006420        |                 |                 |                 |                 |                 |
| Major Axis             | b      | 0.015015        |                 |                 |                 |                 |                 |
| Ellipse Rotation Angle | $\Phi$ | -34.33          |                 |                 |                 |                 |                 |

The color ranks have chromaticity ranges within 7-step MacAdam ellipse.

|                        |        | Rank<br>sm2770a | Rank<br>sm2770b | Rank<br>sm2770c | Rank<br>sm2770d | Rank<br>sm2770e | Rank<br>sm2770f |
|------------------------|--------|-----------------|-----------------|-----------------|-----------------|-----------------|-----------------|
| Center Point           | x      | 0.4578          |                 |                 |                 |                 |                 |
|                        | y      | 0.4101          |                 |                 |                 |                 |                 |
| Minor Axis             | a      | 0.009464        |                 |                 |                 |                 |                 |
| Major Axis             | b      | 0.018368        |                 |                 |                 |                 |                 |
| Ellipse Rotation Angle | $\Phi$ | -36.05          |                 |                 |                 |                 |                 |

|                        |        | Rank<br>sm3070a | Rank<br>sm3070b | Rank<br>sm3070c | Rank<br>sm3070d | Rank<br>sm3070e | Rank<br>sm3070f |
|------------------------|--------|-----------------|-----------------|-----------------|-----------------|-----------------|-----------------|
| Center Point           | x      | 0.4338          |                 |                 |                 |                 |                 |
|                        | y      | 0.4030          |                 |                 |                 |                 |                 |
| Minor Axis             | a      | 0.009583        |                 |                 |                 |                 |                 |
| Major Axis             | b      | 0.019579        |                 |                 |                 |                 |                 |
| Ellipse Rotation Angle | $\Phi$ | -36.00          |                 |                 |                 |                 |                 |

|                        |        | Rank<br>sm3570a | Rank<br>sm3570b | Rank<br>sm3570c | Rank<br>sm3570d | Rank<br>sm3570e | Rank<br>sm3570f |
|------------------------|--------|-----------------|-----------------|-----------------|-----------------|-----------------|-----------------|
| Center Point           | x      | 0.4073          |                 |                 |                 |                 |                 |
|                        | y      | 0.3917          |                 |                 |                 |                 |                 |
| Minor Axis             | a      | 0.009562        |                 |                 |                 |                 |                 |
| Major Axis             | b      | 0.020524        |                 |                 |                 |                 |                 |
| Ellipse Rotation Angle | $\Phi$ | -35.47          |                 |                 |                 |                 |                 |

|                        |        | Rank sm4070a | Rank sm4070b | Rank sm4070c | Rank sm4070d | Rank sm4070e | Rank sm4070f |
|------------------------|--------|--------------|--------------|--------------|--------------|--------------|--------------|
| Center Point           | x      | 0.3818       |              |              |              |              |              |
|                        | y      | 0.3797       |              |              |              |              |              |
| Minor Axis             | a      | 0.009499     |              |              |              |              |              |
| Major Axis             | b      | 0.021658     |              |              |              |              |              |
| Ellipse Rotation Angle | $\Phi$ | -35.95       |              |              |              |              |              |

|                        |        | Rank sm4570a | Rank sm4570b | Rank sm4570c | Rank sm4570d | Rank sm4570e | Rank sm4570f |
|------------------------|--------|--------------|--------------|--------------|--------------|--------------|--------------|
| Center Point           | x      | 0.3611       |              |              |              |              |              |
|                        | y      | 0.3658       |              |              |              |              |              |
| Minor Axis             | a      | 0.008988     |              |              |              |              |              |
| Major Axis             | b      | 0.021021     |              |              |              |              |              |
| Ellipse Rotation Angle | $\Phi$ | -34.33       |              |              |              |              |              |

- \* Ranking at  $T_s=25^\circ\text{C}$ .
- \* Forward Voltage Tolerance:  $\pm 0.05\text{V}$
- \* Luminous Flux Tolerance:  $\pm 7\%$
- \* Color Rendering Index  $R_a$  Tolerance:  $\pm 2$
- \* Color Rendering Index  $R_9$  Tolerance:  $\pm 6.5$
- \* The  $R_9$  value for the above rank shall be greater than 0.
- \* Chromaticity Coordinate Tolerance:  $\pm 0.005$
- \* LEDs from the above ranks will be shipped. The rank combination ratio per shipment will be decided by Nichia.

Definition of the MacAdam ellipse ranks:

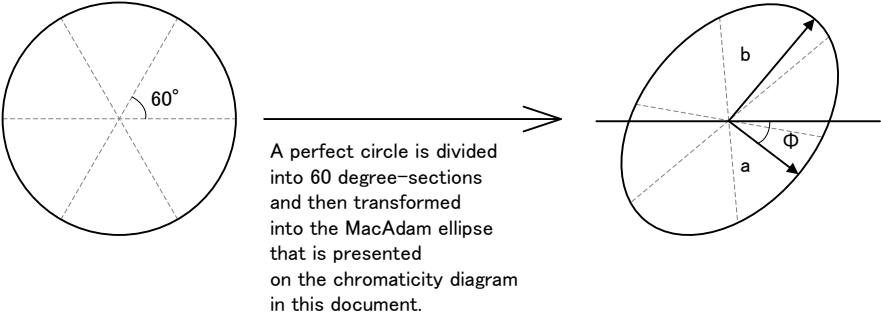

Luminous Flux Ranks by Color Rank, Color Rendering Index Rank

| Ranking by<br>Color Coordinates,<br>Color Rendering Index   |       | Ranking by<br>Luminous Flux |  | D180 | D200 | D220 | D240 | D260 | D280 | D300 | D320 | D340 |
|---|-------|-----------------------------|--|------|------|------|------|------|------|------|------|------|
|   |       |                             |  |      |      |      |      |      |      |      |      |      |
| sm273,sm2750a,sm2750b,sm2750c,<br>sm2750d,sm2750e,sm2750f,<br>sm2770a,sm2770b,sm2770c,<br>sm2770d,sm2770e,sm2770f | R70   |                             |  |      |      |      |      |      |      |      |      |      |
|   | R8000 |                             |  |      |      |      |      |      |      |      |      |      |
|   | R9050 |                             |  |      |      |      |      |      |      |      |      |      |
| sm303,sm3050a,sm3050b,sm3050c,<br>sm3050d,sm3050e,sm3050f,<br>sm3070a,sm3070b,sm3070c,<br>sm3070d,sm3070e,sm3070f | R70   |                             |  |      |      |      |      |      |      |      |      |      |
|   | R8000 |                             |  |      |      |      |      |      |      |      |      |      |
|   | R9050 |                             |  |      |      |      |      |      |      |      |      |      |
| sm353,sm3550a,sm3550b,sm3550c,<br>sm3550d,sm3550e,sm3550f,<br>sm3570a,sm3570b,sm3570c,<br>sm3570d,sm3570e,sm3570f | R70   |                             |  |      |      |      |      |      |      |      |      |      |
|   | R8000 |                             |  |      |      |      |      |      |      |      |      |      |
|   | R9050 |                             |  |      |      |      |      |      |      |      |      |      |
| sm403,sm4050a,sm4050b,sm4050c,<br>sm4050d,sm4050e,sm4050f,<br>sm4070a,sm4070b,sm4070c,<br>sm4070d,sm4070e,sm4070f | R70   |                             |  |      |      |      |      |      |      |      |      |      |
|   | R8000 |                             |  |      |      |      |      |      |      |      |      |      |
|   | R9050 |                             |  |      |      |      |      |      |      |      |      |      |
| sm453,sm4550a,sm4550b,sm4550c,<br>sm4550d,sm4550e,sm4550f,<br>sm4570a,sm4570b,sm4570c,<br>sm4570d,sm4570e,sm4570f | R70   |                             |  |      |      |      |      |      |      |      |      |      |
|   | R8000 |                             |  |      |      |      |      |      |      |      |      |      |

# CHROMATICITY DIAGRAM

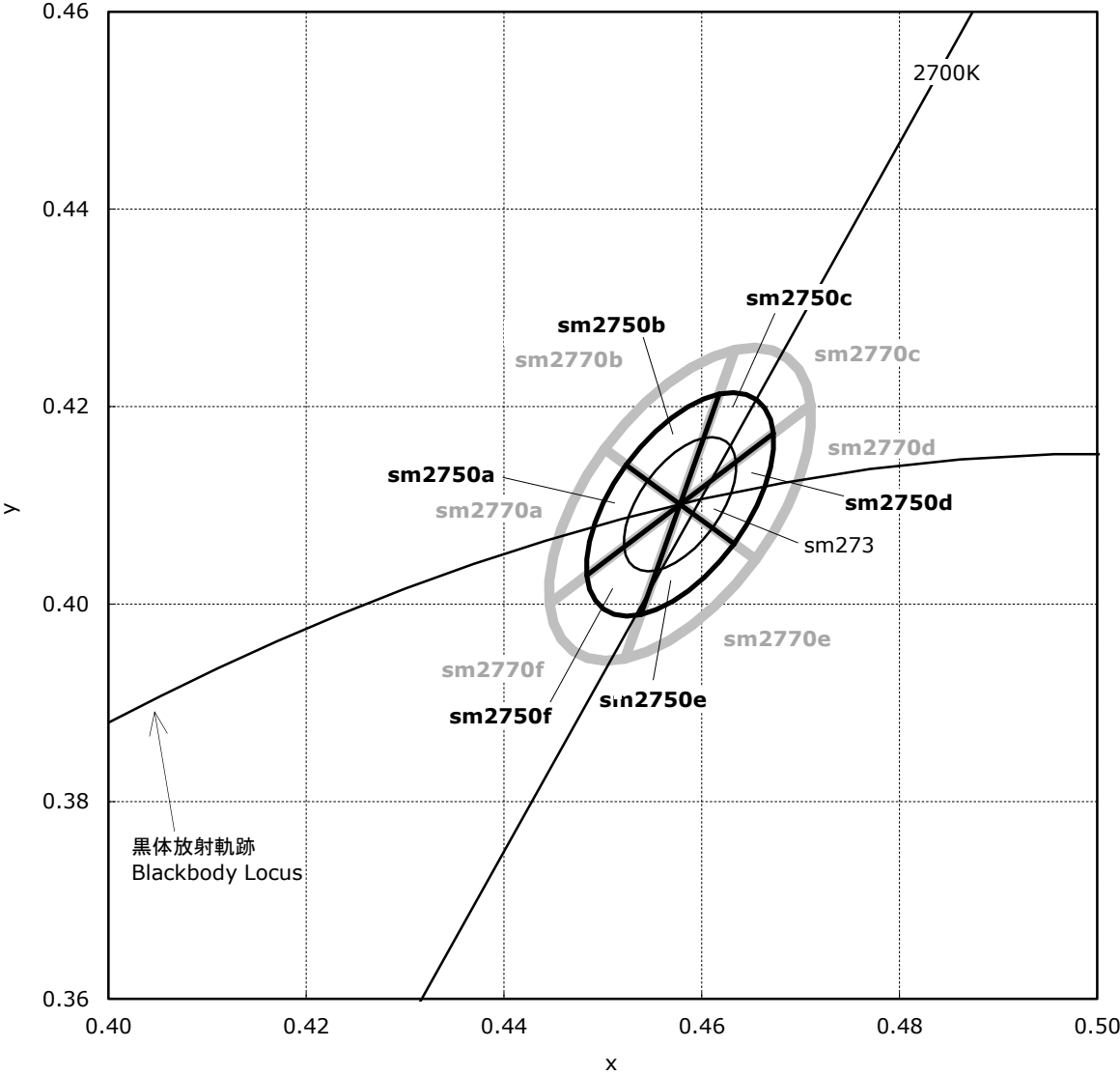

# CHROMATICITY DIAGRAM

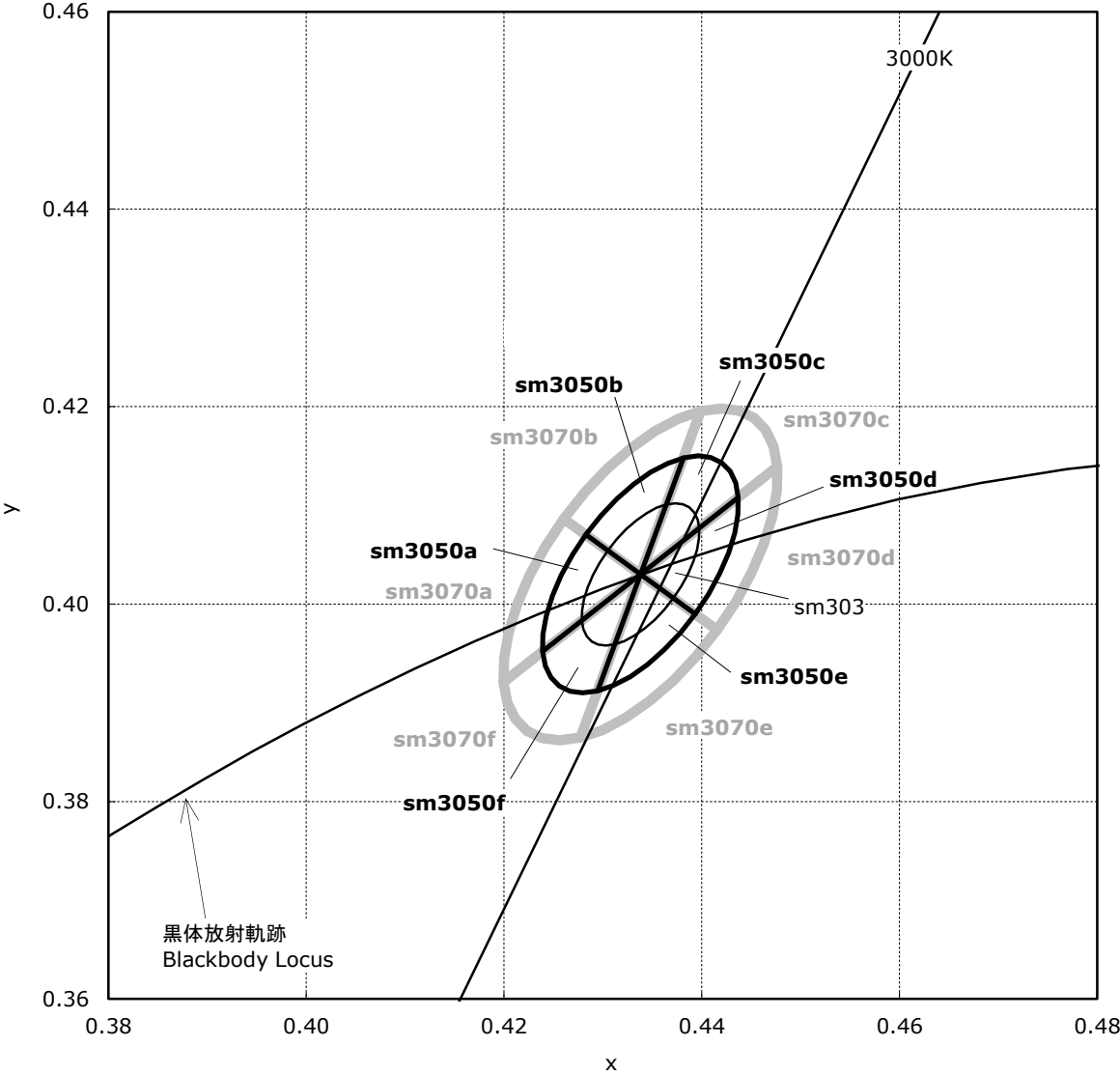



# CHROMATICITY DIAGRAM

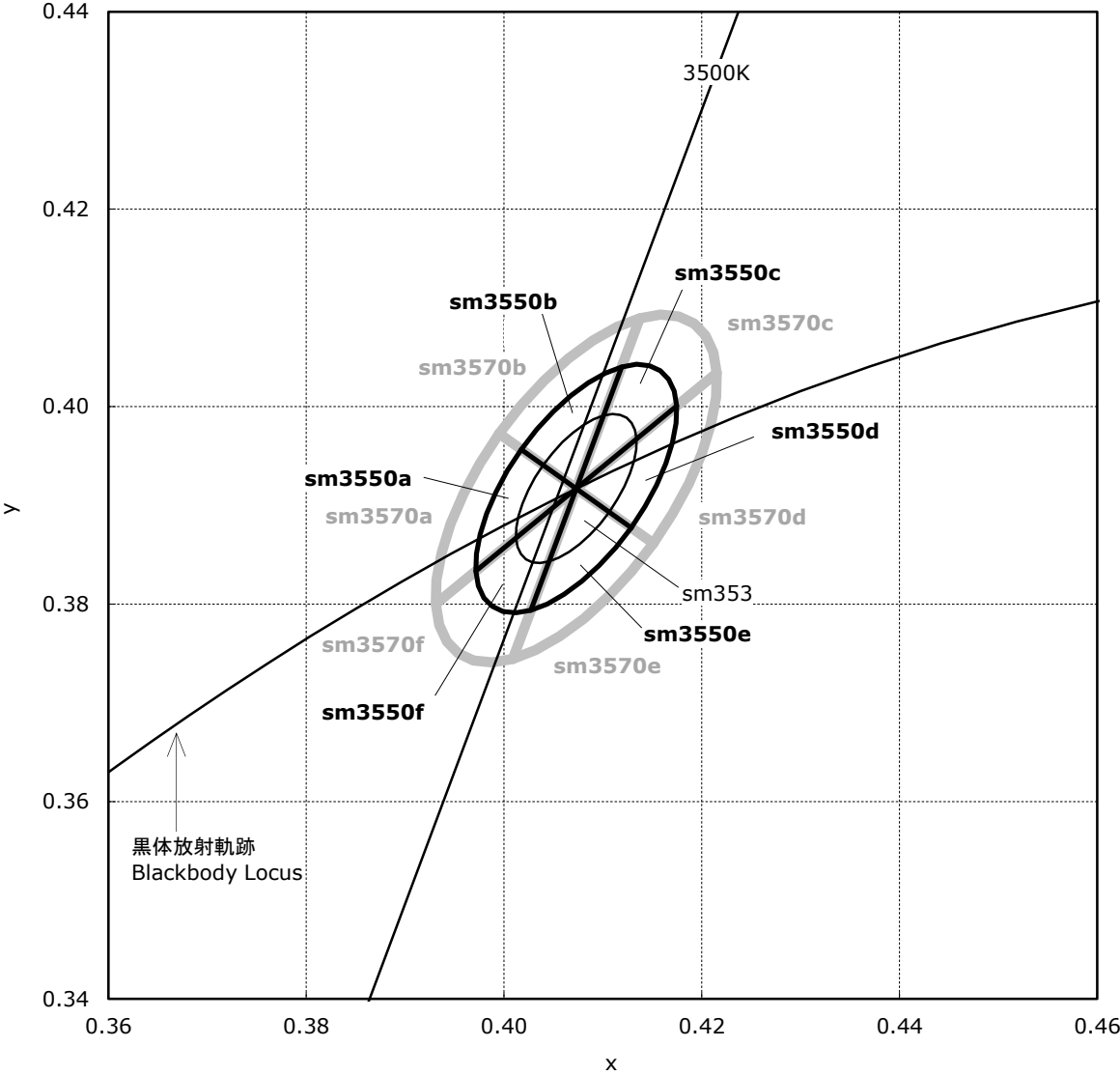

# CHROMATICITY DIAGRAM

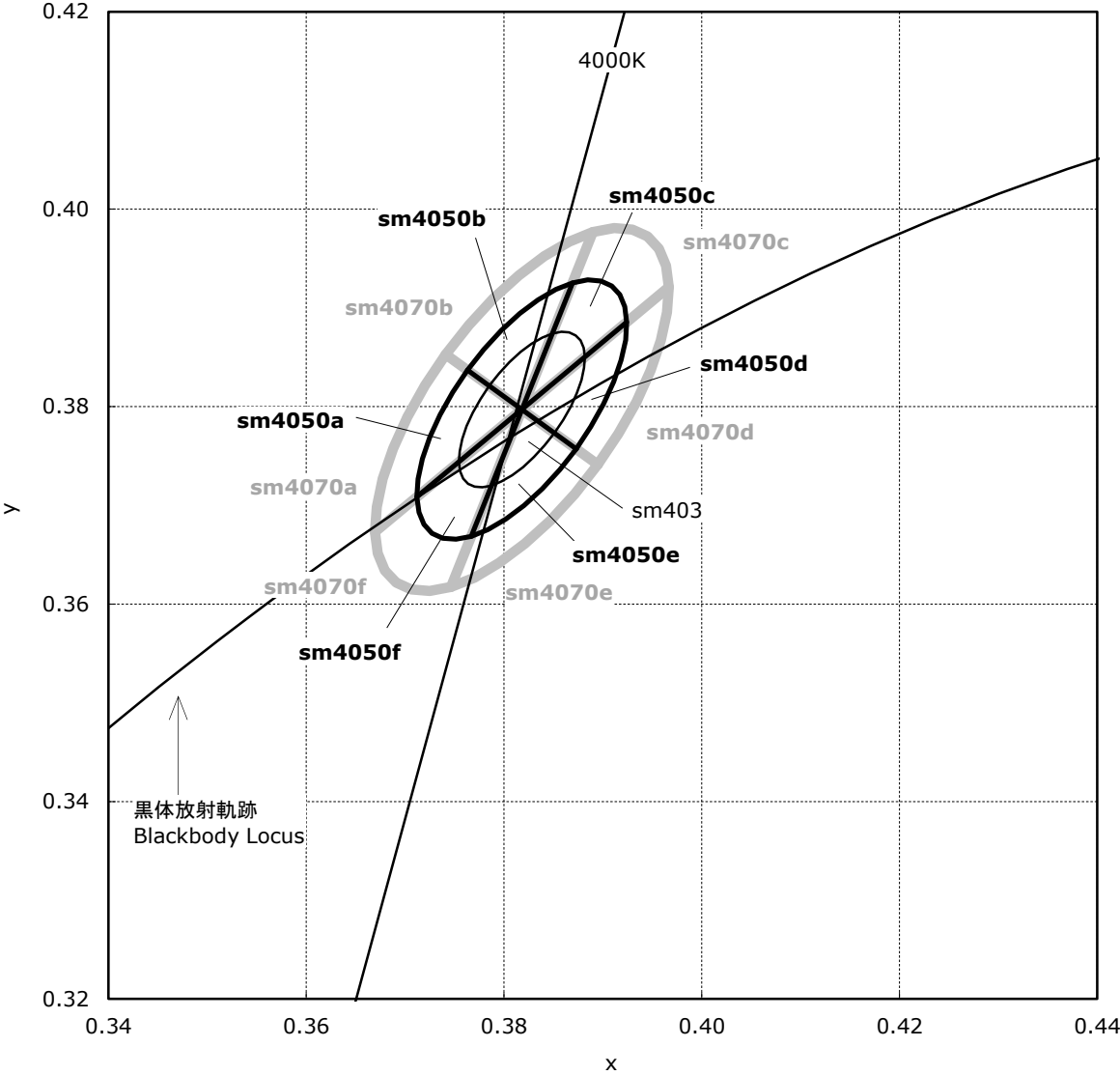

# CHROMATICITY DIAGRAM

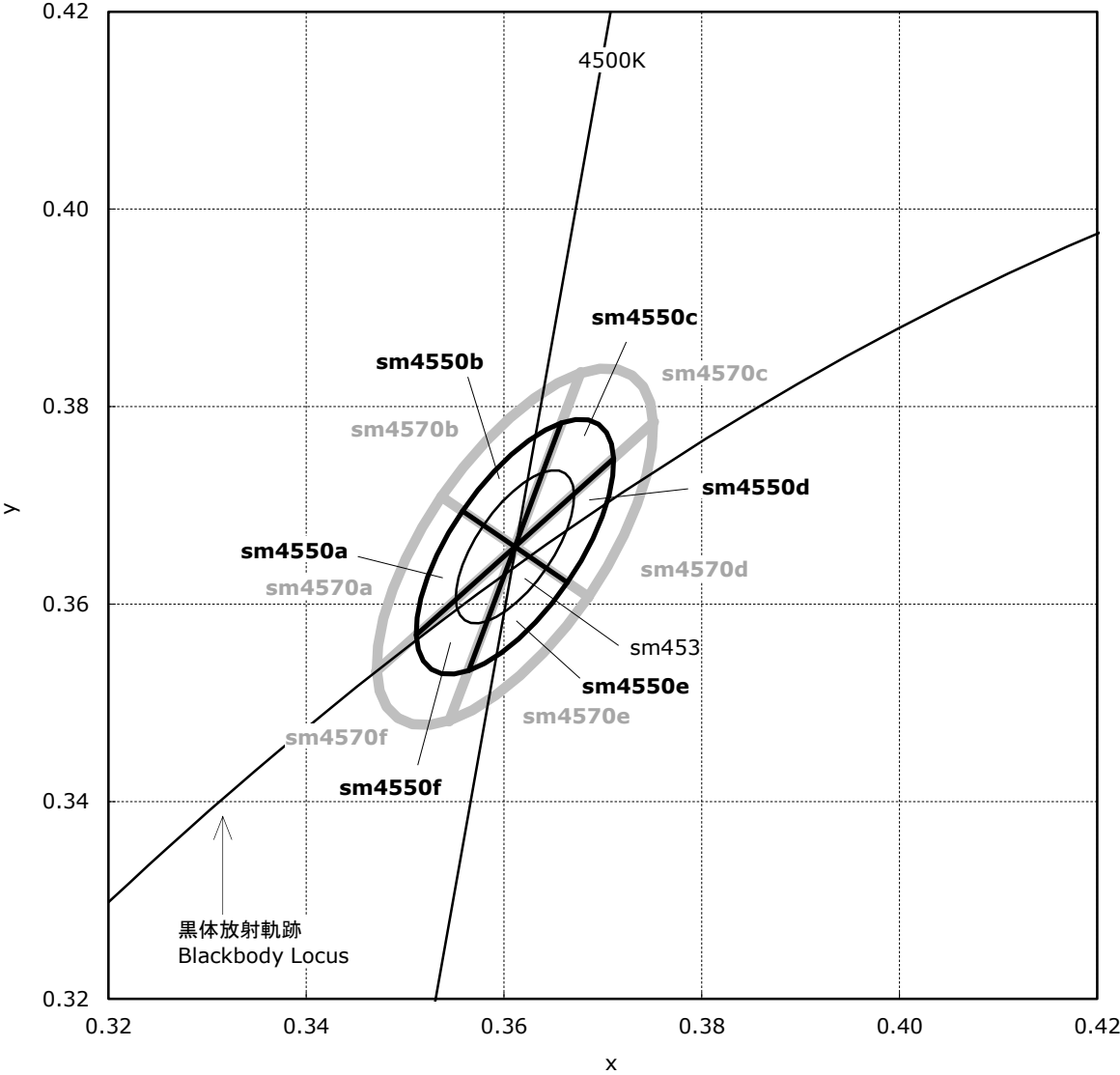

# OUTLINE DIMENSIONS

\* 本製品はRoHS指令に適合しております。  
This product complies with RoHS Directive.

NVSL219C  
管理番号 No. STS-DA7-6488B

(単位 Unit: mm, 公差 Tolerance: ±0.2)

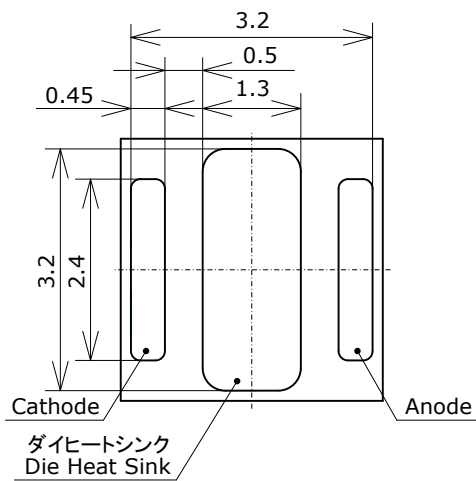
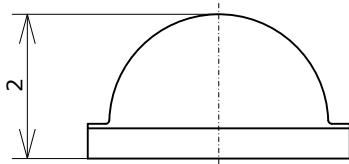
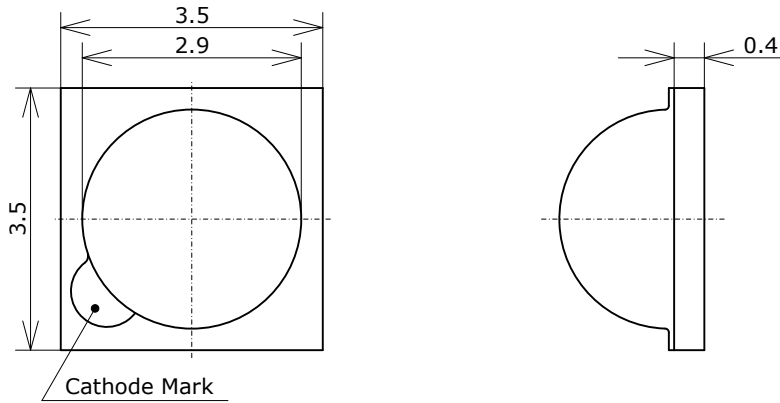

| 項目 Item                                  | 内容 Description                                   |
|--|--|
| パッケージ材質<br>Package Materials             | セラミックス<br>Ceramics                               |
| プリコート材質<br>Pre-coating<br>Materials      | シリコン樹脂 (蛍光体入り)<br>Silicone Resin (with phosphor) |
| レンズ材質<br>Lens Materials                  | シリコン樹脂<br>Silicone Resin                         |
| 電極材質<br>Electrodes Materials             | 金メッキ<br>Au-plated                                |
| ダイヒートシンク材質<br>Die Heat Sink<br>Materials | 金メッキ<br>Au-plated                                |
| 質量<br>Weight                             | 0.031g (TYP)                                     |

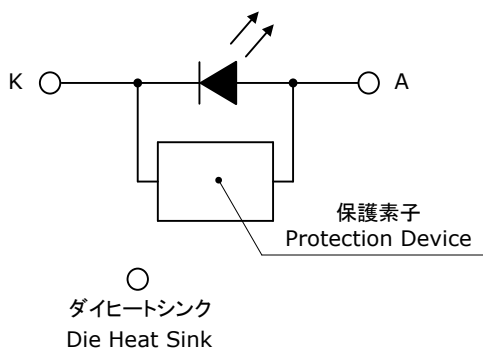



- 
- \* Once the LEDs have been soldered to a PCB, it should not be repaired/reworked. If it must be done, using a hot plate is strongly recommended. Sufficient verification should be performed prior to use to ensure that the repair/rework does not cause the LED characteristics to deteriorate.
  - \* The Die Heat Sink should be soldered to customer PCB. If it is difficult or impossible, use high heat-dissipating adhesive.
  - \* When soldering, do not apply stress to the LED while the LED is hot.
  - \* The soldering pad pattern above is a general recommendation for LEDs to be mounted without issues; if a high degree of precision is required for the chosen application (i.e. high-density mounting), ensure that the soldering pad pattern is optimized.
  - \* When flux is used, it should be a halogen free flux. Ensure that the manufacturing process is not designed in a manner where the flux will come in contact with the LEDs.
  - \* Ensure that there are no issues with the type and amount of solder that is being used.
  - \* This LED has all the electrodes on the backside; solder connections will not be able to be seen nor confirmed by a normal visual inspection. Ensure that sufficient verification is performed on the soldering conditions prior to use to ensure that there are no issues.

TAPE AND REEL DIMENSIONS

テーピング部 Tape

Nxxx219x  
管理番号 No. STS-DA7-6927

(単位 Unit: mm)

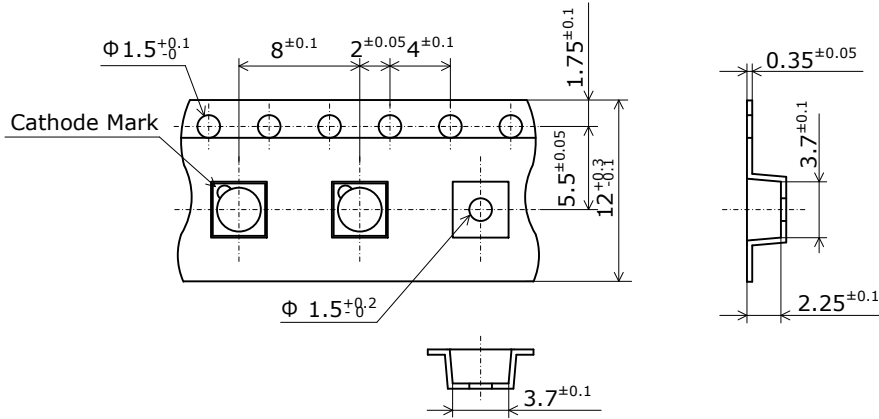

トレーラ部/リーダ部 Trailer and Leader

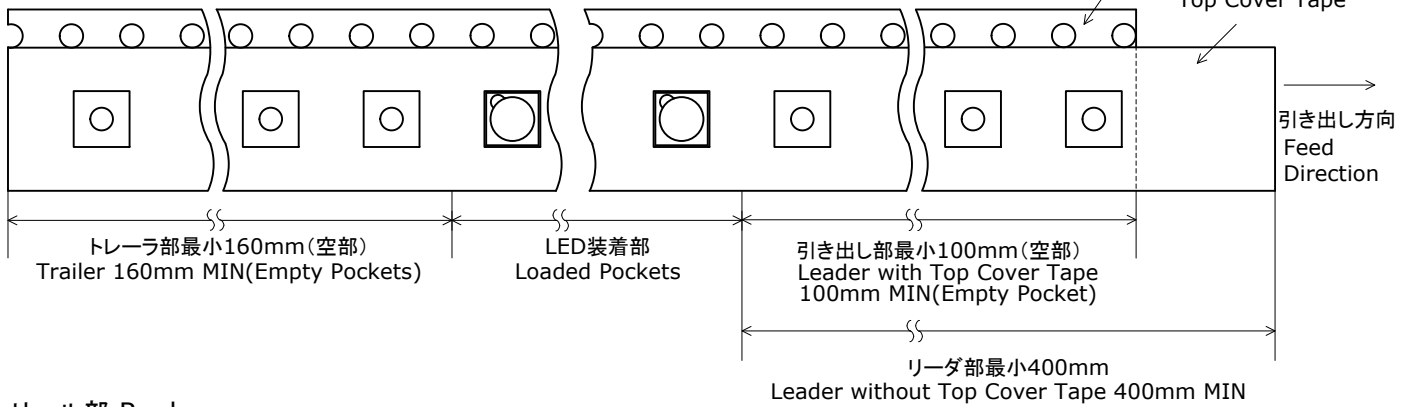

リール部 Reel

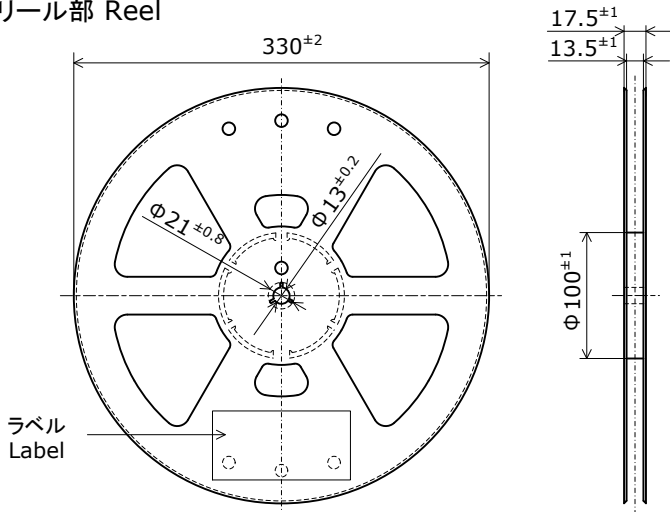

- \* 数量は1リールにつき 3500個入りです。  
Reel Size: 3500pcs
- \* JIS C 0806電子部品テーピングに準拠しています。  
The tape packing method complies with JIS C 0806 (Packaging of Electronic Components on Continuous Tapes).
- \* 実装作業の中断などでエンボスキャリアテープをリールに巻き取る場合、エンボスキャリアテープを強く(10N以上)締めないで下さい。LEDがカバーテープに貼り付く可能性があります。  
When the tape is rewound due to work interruptions, no more than 10N should be applied to the embossed carrier tape. The LEDs may stick to the top cover tape.

## PACKAGING - TAPE &amp; REEL

シリカゲルとともにリールをアルミ防湿袋に入れ、熱シールにより封をします。  
Reels are shipped with desiccants in heat-sealed moisture-proof bags.

Nxxxxxxx  
管理番号 No. STS-DA7-4989

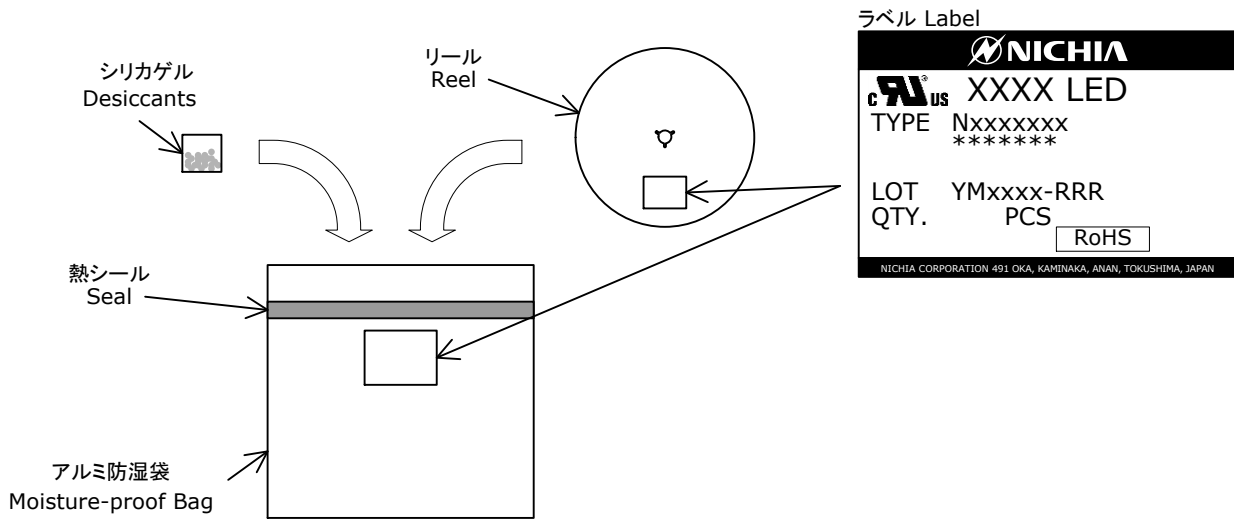

アルミ防湿袋を並べて入れ、ダンボールで仕切ります。  
Moisture-proof bags are packed in cardboard boxes with corrugated partitions.

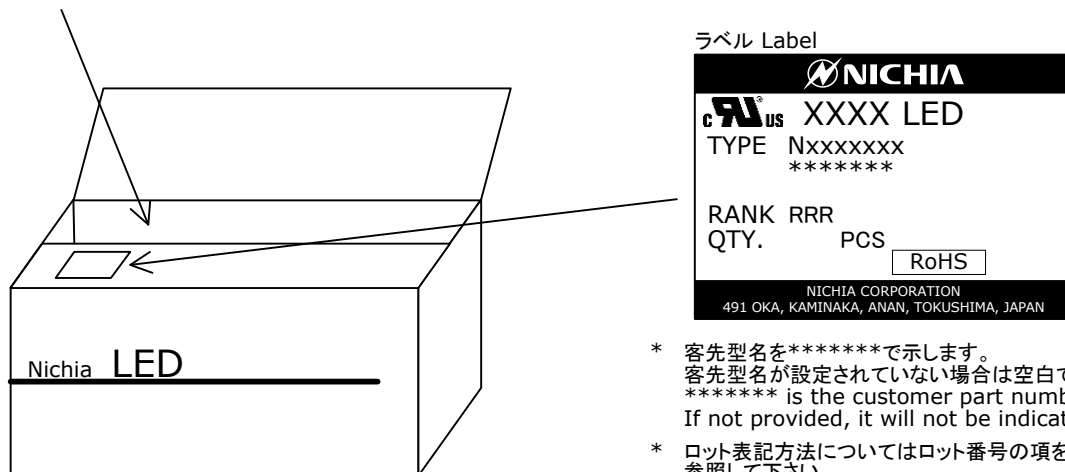

- \* 客先型名を\*\*\*\*\*で示します。  
客先型名が設定されていない場合は空白です。  
\*\*\*\*\* is the customer part number.  
If not provided, it will not be indicated on the label.
- \* ロット表記方法についてはロット番号の項を参照して下さい。  
For details, see "LOT NUMBERING CODE" in this document.
- \* ランク分けがない場合はランク表記はありません。  
The label does not have the RANK field for un-ranked products.

- \* 本製品はテーピングしたのち、輸送の衝撃から保護するためダンボールで梱包します。  
Products shipped on tape and reel are packed in a moisture-proof bag.  
They are shipped in cardboard boxes to protect them from external forces during transportation.
- \* 取り扱いに際して、落下させたり、強い衝撃を与えたりしますと、製品を損傷させる原因になりますので注意して下さい。  
Do not drop or expose the box to external forces as it may damage the products.
- \* ダンボールには防水加工がされておりませんので、梱包箱が水に濡れないよう注意して下さい。  
Do not expose to water. The box is not water-resistant.
- \* 輸送、運搬に際して弊社よりの梱包状態あるいは同等の梱包を行って下さい。  
Using the original package material or equivalent in transit is recommended.



# LOT NUMBERING CODE

Lot Number is presented by using the following alphanumeric code.

YMxxxx - RRR

Y - Year

| Year | Y |
|------|---|
| 2017 | H |
| 2018 | I |
| 2019 | J |
| 2020 | K |
| 2021 | L |
| 2022 | M |

M - Month

| Month | M | Month | M |
|-------|---|-------|---|
| 1     | 1 | 7     | 7 |
| 2     | 2 | 8     | 8 |
| 3     | 3 | 9     | 9 |
| 4     | 4 | 10    | A |
| 5     | 5 | 11    | B |
| 6     | 6 | 12    | C |

xxxx-Nichia's Product Number

RRR-Ranking by Color Coordinates, Ranking by Luminous Flux, Ranking by Forward Voltage, Ranking by Color Rendering Index

# DERATING CHARACTERISTICS

NVSx219C  
管理番号 No. STS-DA7-6918

周囲温度-許容順電流特性

Ambient Temperature vs  
Allowable Forward Current

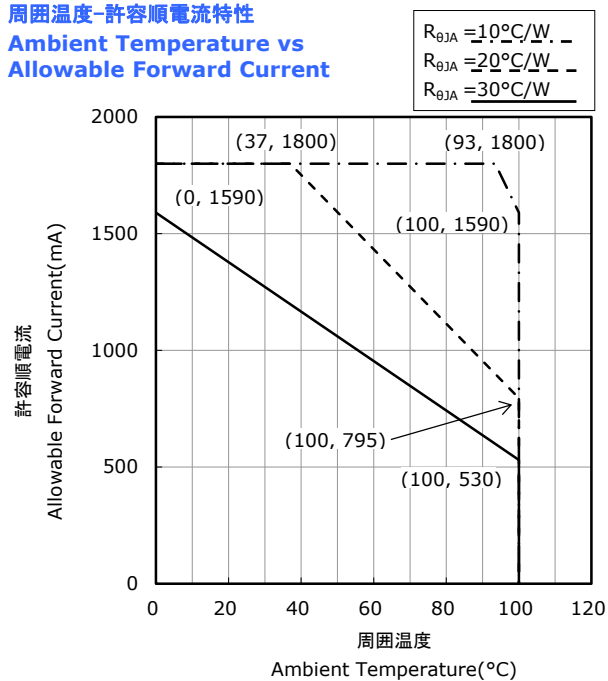

はんだ接合部温度(カソード側)-許容順電流特性

Solder Temperature(Cathode Side) vs  
Allowable Forward Current

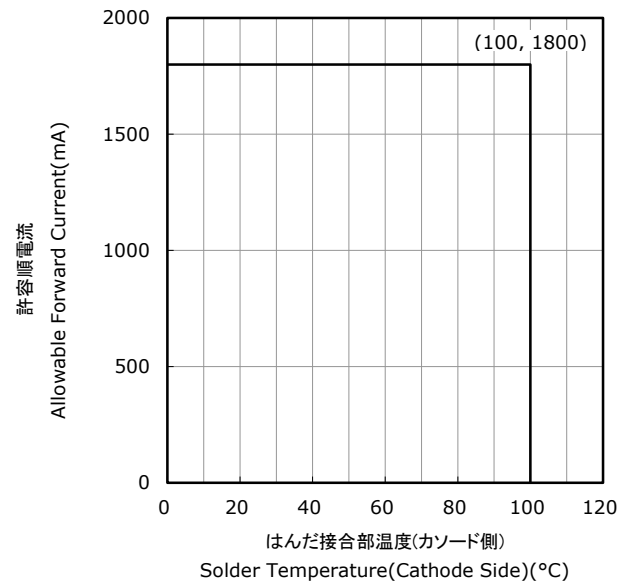

デューティー比-許容順電流特性

Duty Ratio vs  
Allowable Forward Current

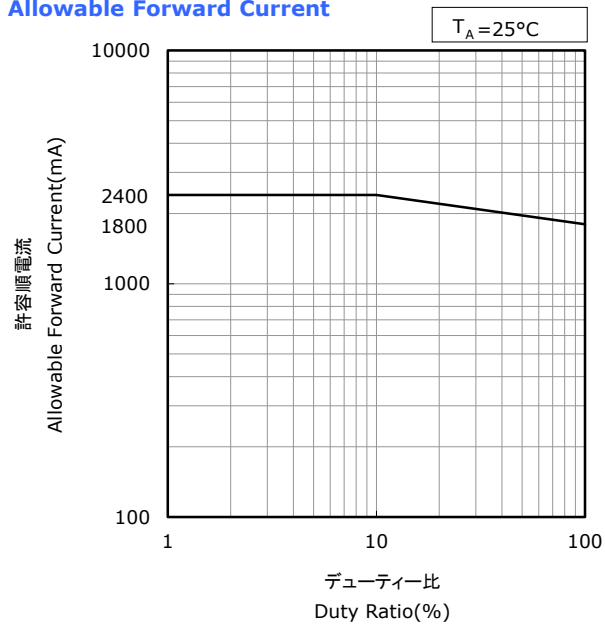

# OPTICAL CHARACTERISTICS

\* 本特性は参考です。  
All characteristics shown are for reference only and are not guaranteed.

NVSL219C  
管理番号 No. STS-DA7-7205

## 発光スペクトル Spectrum

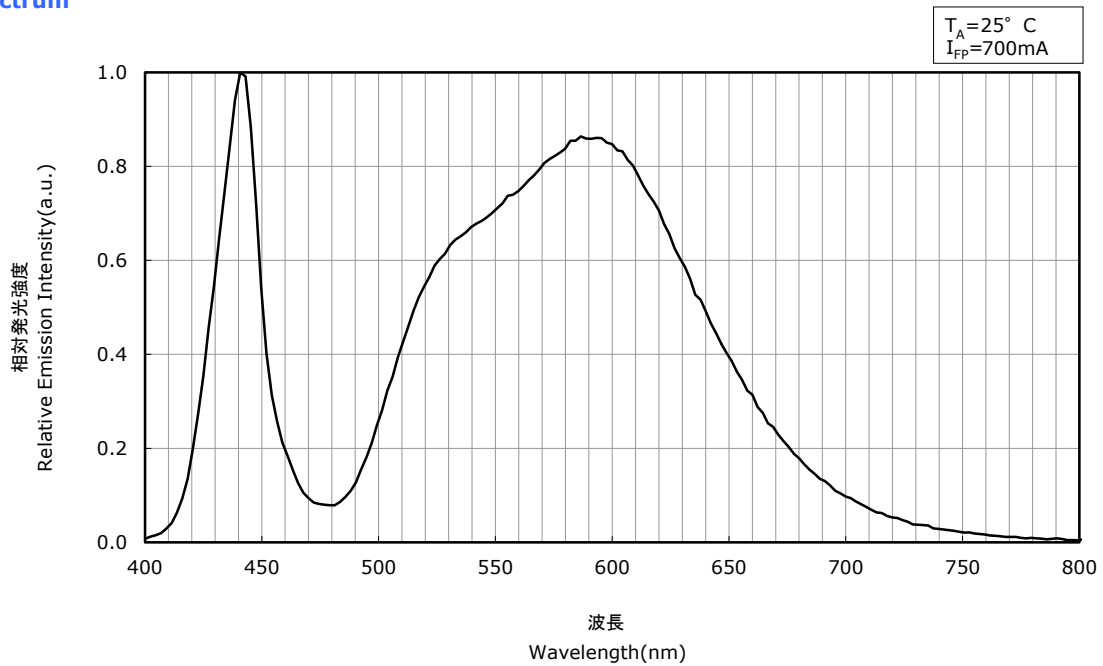

## 指向特性 Directivity

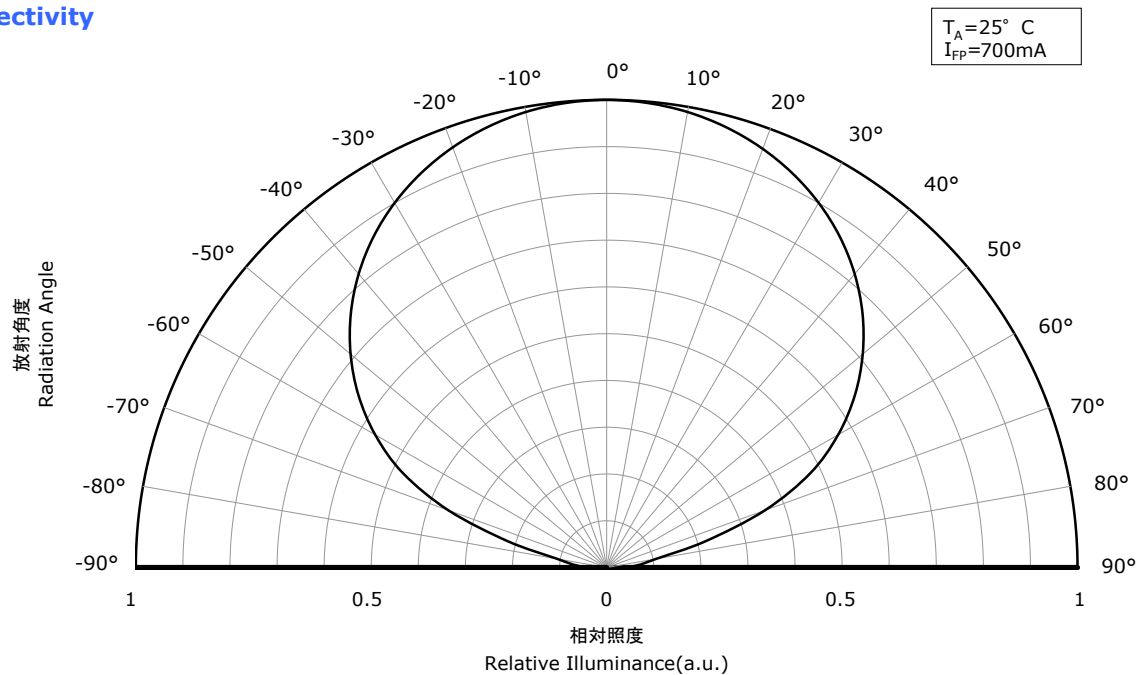

\* 本特性は演色性ランクR70に対応しています。  
The graphs above show the characteristics for R70 LEDs of this product.

# OPTICAL CHARACTERISTICS

\* 本特性は参考です。  
All characteristics shown are for reference only and are not guaranteed.

NVSL219C  
管理番号 No. STS-DA7-6955A

## 発光スペクトル Spectrum

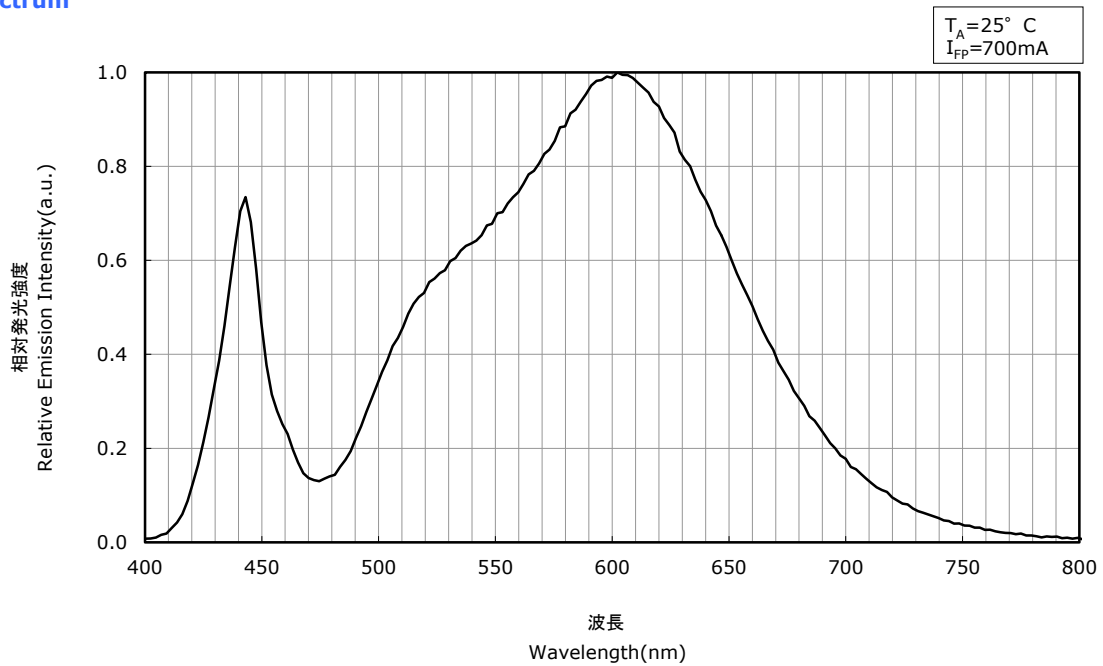

## 指向特性 Directivity

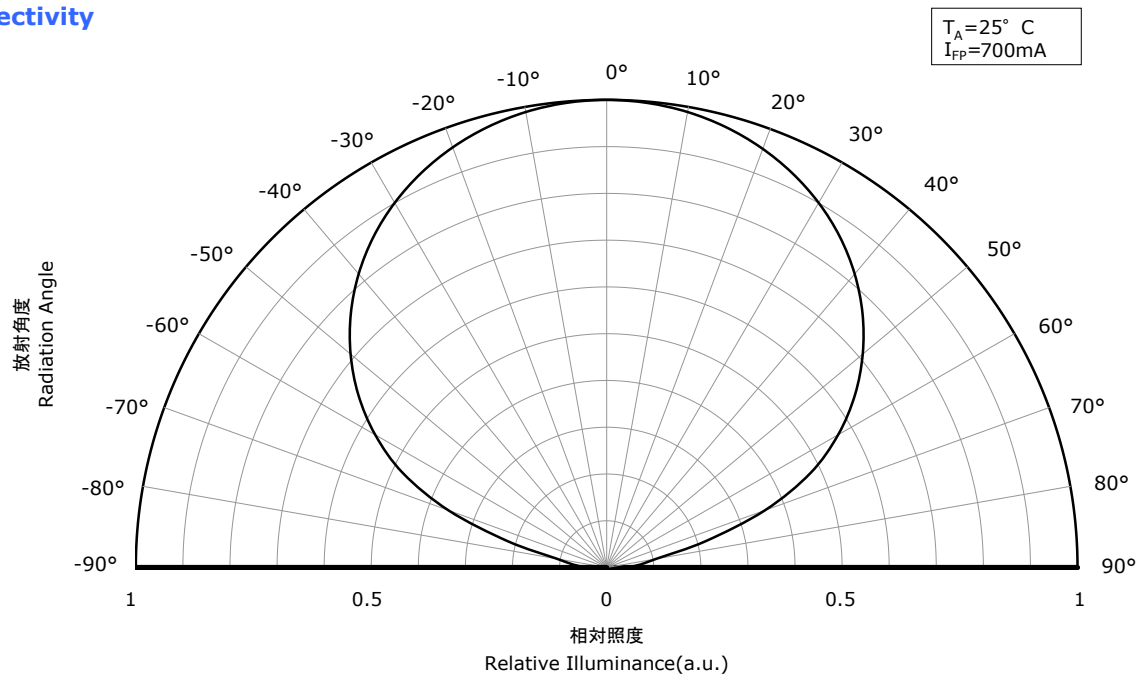

\* 本特性は演色性ランクR8000に対応しています。  
The graphs above show the characteristics for R8000 LEDs of this product.

# OPTICAL CHARACTERISTICS

\* 本特性は参考です。  
All characteristics shown are for reference only and are not guaranteed.

NVSL219C  
管理番号 No. STS-DA7-9743

## 発光スペクトル Spectrum

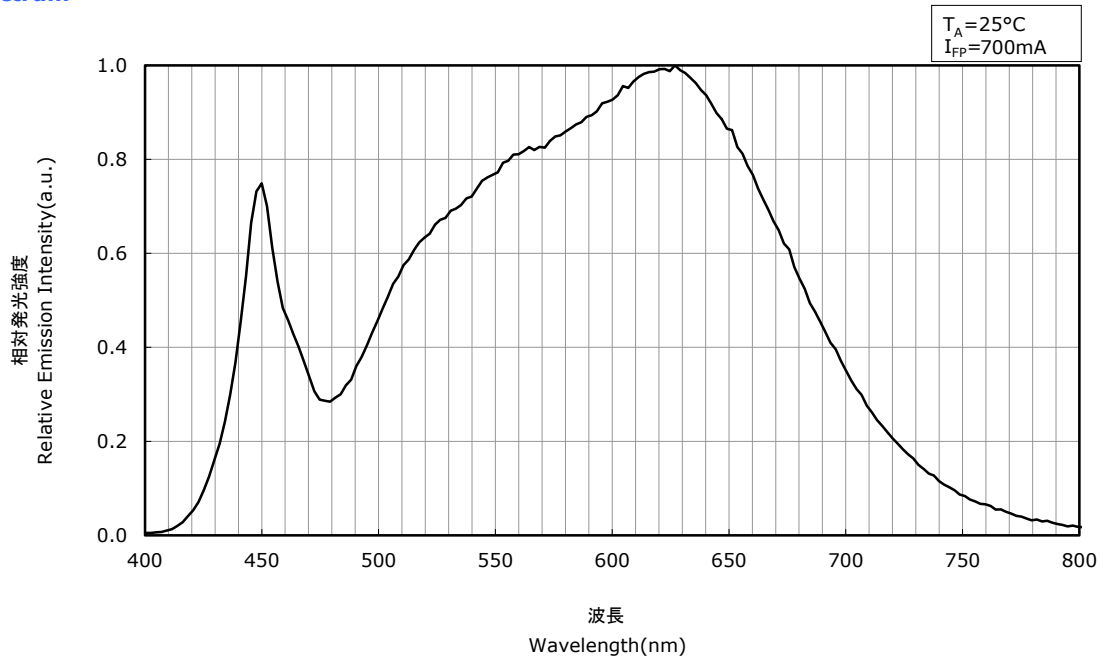

## 指向特性 Directivity

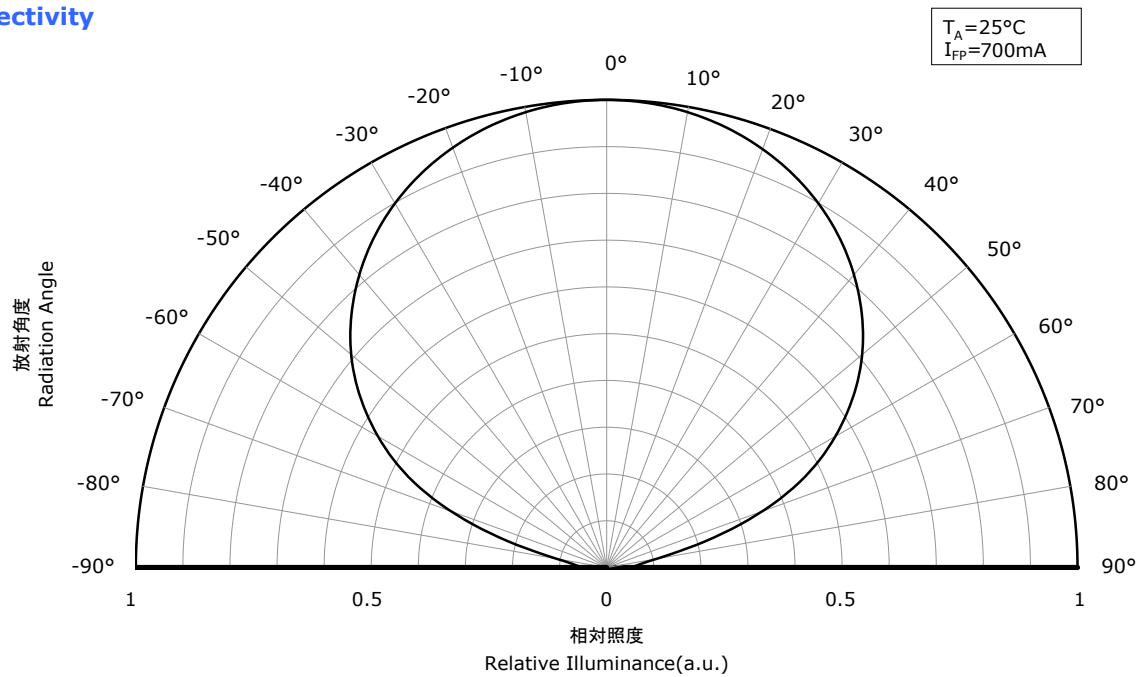

\* 本特性は演色性ランクR9050に対応しています。  
The graphs above show the characteristics for R9050 LEDs of this product.

# FORWARD CURRENT CHARACTERISTICS / TEMPERATURE CHARACTERISTICS

\* 本特性は参考です。  
All characteristics shown are for reference only and are not guaranteed.

NVSL219C  
管理番号 No. STS-DA7-6486C

**順電圧-順電流特性**  
**Forward Voltage vs Forward Current**

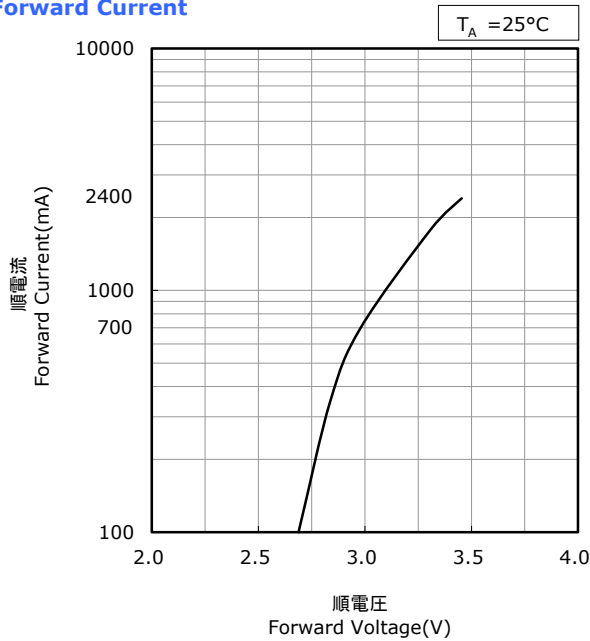

**周囲温度-順電圧特性**  
**Ambient Temperature vs Forward Voltage**

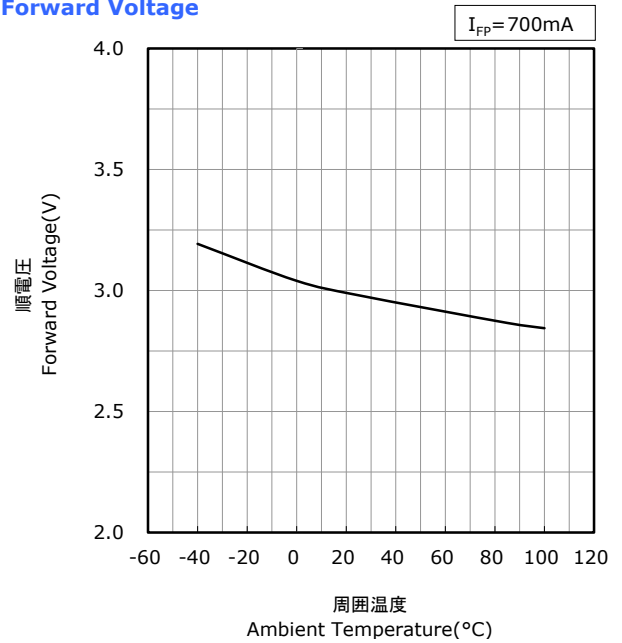

**順電流-相対光束特性**  
**Forward Current vs Relative Luminous Flux**

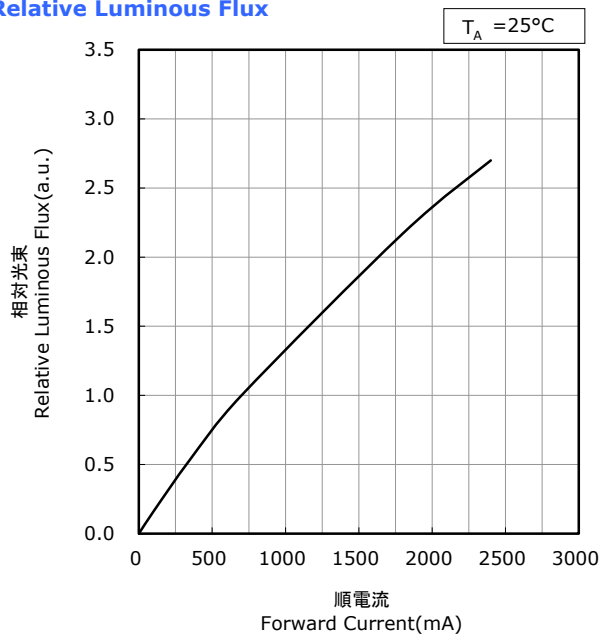

**周囲温度-相対光束特性**  
**Ambient Temperature vs Relative Luminous Flux**

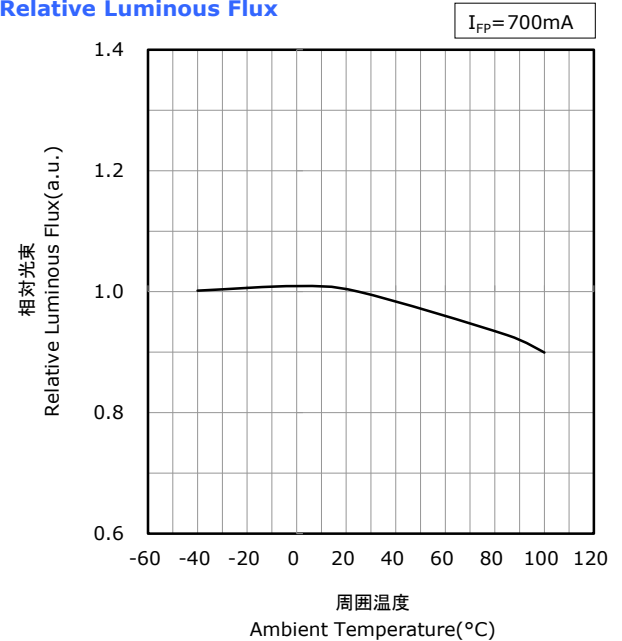

\* 本特性は演色性ランクR70に対応しています。  
The graphs above show the characteristics for R70 LEDs of this product.

# FORWARD CURRENT CHARACTERISTICS / TEMPERATURE CHARACTERISTICS

\* 本特性は参考です。  
All characteristics shown are for reference only and are not guaranteed.

NVSL219C  
管理番号 No. STS-DA7-9798

**順電圧-順電流特性**  
**Forward Voltage vs Forward Current**

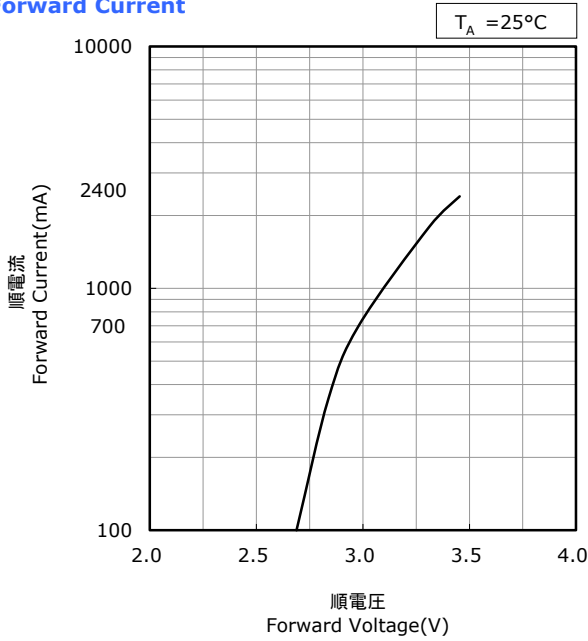

**周囲温度-順電圧特性**  
**Ambient Temperature vs Forward Voltage**

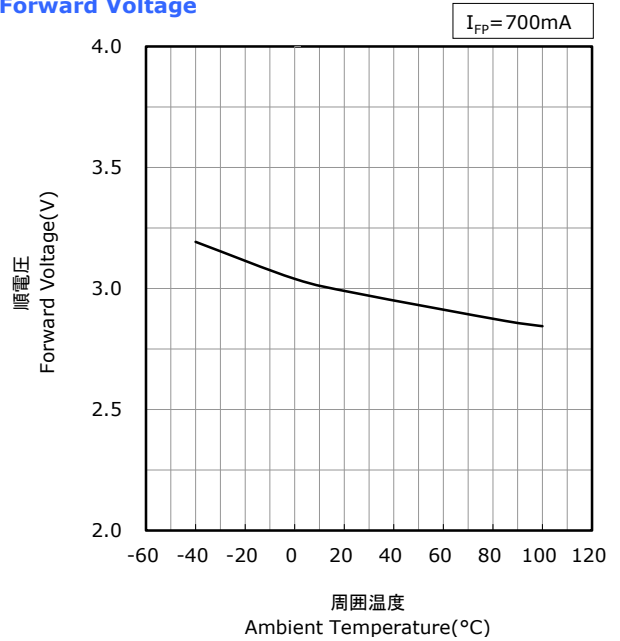

**順電流-相対光束特性**  
**Forward Current vs Relative Luminous Flux**

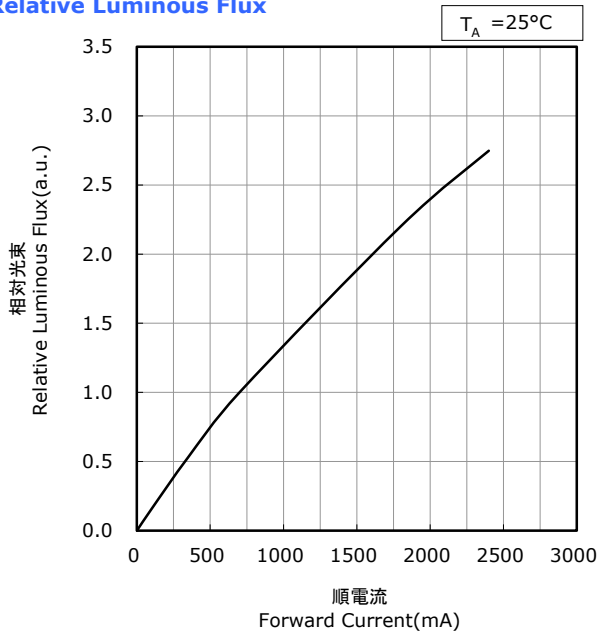

**周囲温度-相対光束特性**  
**Ambient Temperature vs Relative Luminous Flux**

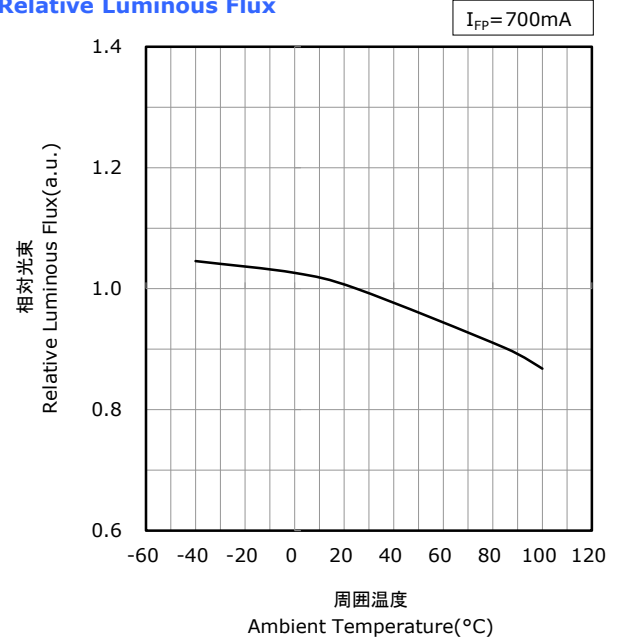

\* 本特性は演色性ランクR8000に対応しています。  
The graphs above show the characteristics for R8000 LEDs of this product.

# FORWARD CURRENT CHARACTERISTICS / TEMPERATURE CHARACTERISTICS

\* 本特性は参考です。  
All characteristics shown are for reference only and are not guaranteed.

NVSL219C  
管理番号 No. STS-DA7-9799

**順電圧-順電流特性**  
**Forward Voltage vs Forward Current**

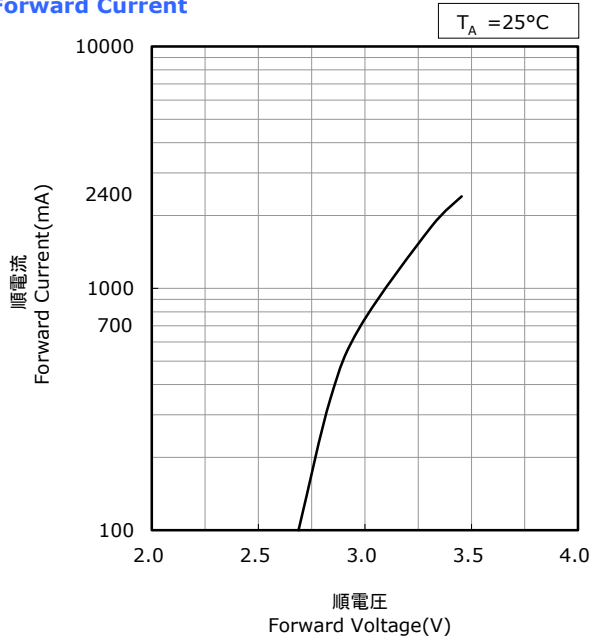

**周囲温度-順電圧特性**  
**Ambient Temperature vs Forward Voltage**

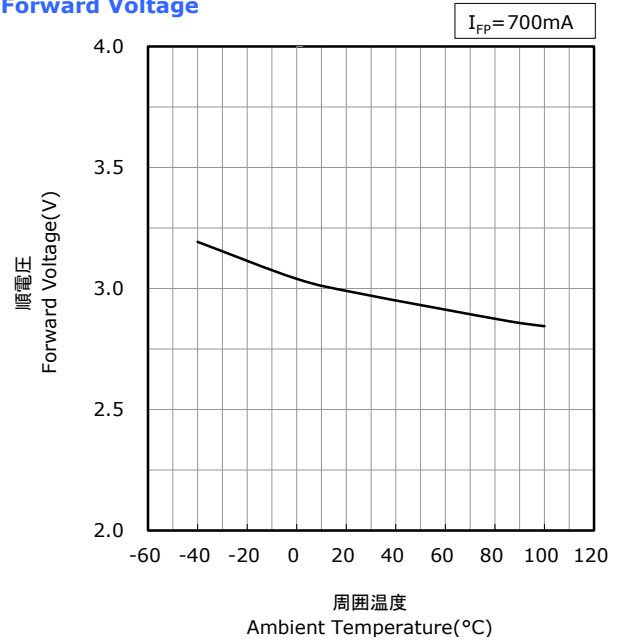

**順電流-相対光束特性**  
**Forward Current vs Relative Luminous Flux**

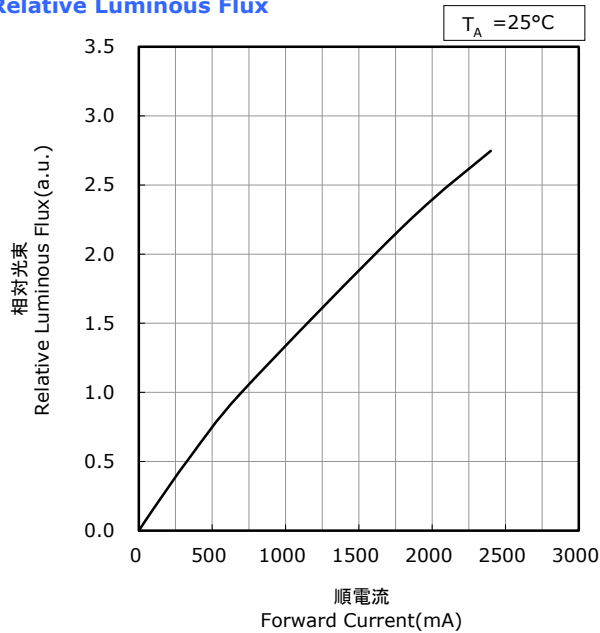

**周囲温度-相対光束特性**  
**Ambient Temperature vs Relative Luminous Flux**

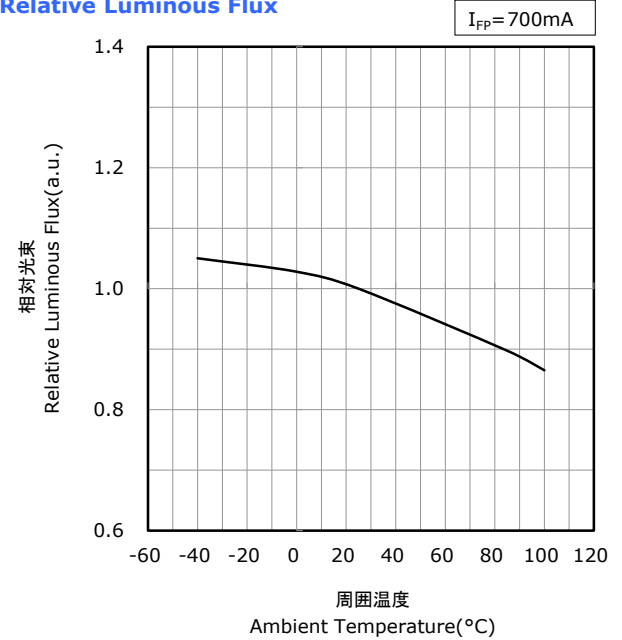

\* 本特性は演色性ランクR9050に対応しています。  
The graphs above show the characteristics for R9050 LEDs of this product.



FORWARD CURRENT CHARACTERISTICS / TEMPERATURE CHARACTERISTICS

\* 本特性は参考です。  
All characteristics shown are for reference only and are not guaranteed.

NVSL219C  
管理番号 No. STS-DA7-7206

順電流-色度 特性  
Forward Current vs Chromaticity Coordinate

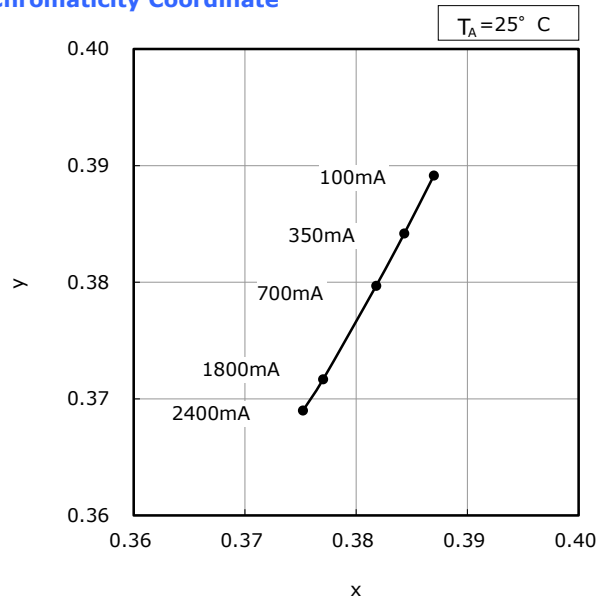

周囲温度-色度 特性  
Ambient Temperature vs Chromaticity Coordinate

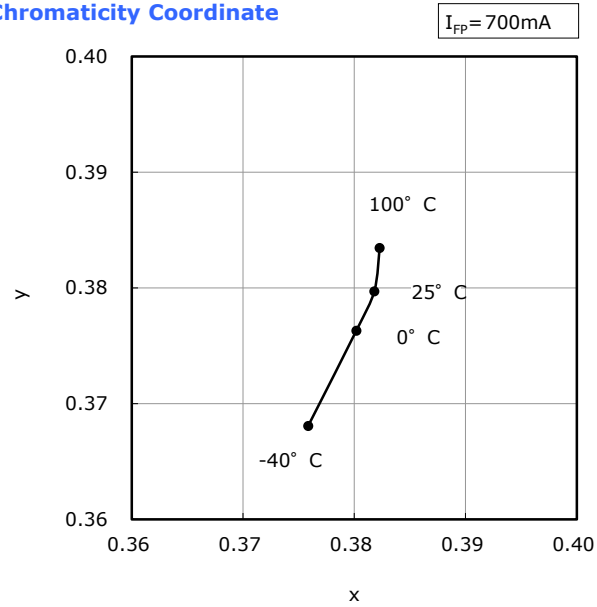

\* 本特性は演色性ランクR70に対応しています。  
The graphs above show the characteristics for R70 LEDs of this product.

FORWARD CURRENT CHARACTERISTICS / TEMPERATURE CHARACTERISTICS

\* 本特性は参考です。  
All characteristics shown are for reference only and are not guaranteed.

NVSL219C  
管理番号 No. STS-DA7-6959A

順電流-色度 特性  
Forward Current vs Chromaticity Coordinate

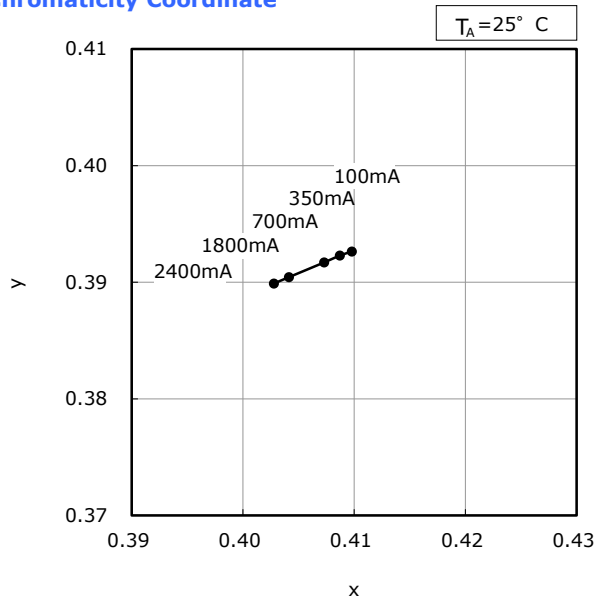

周囲温度-色度 特性  
Ambient Temperature vs Chromaticity Coordinate

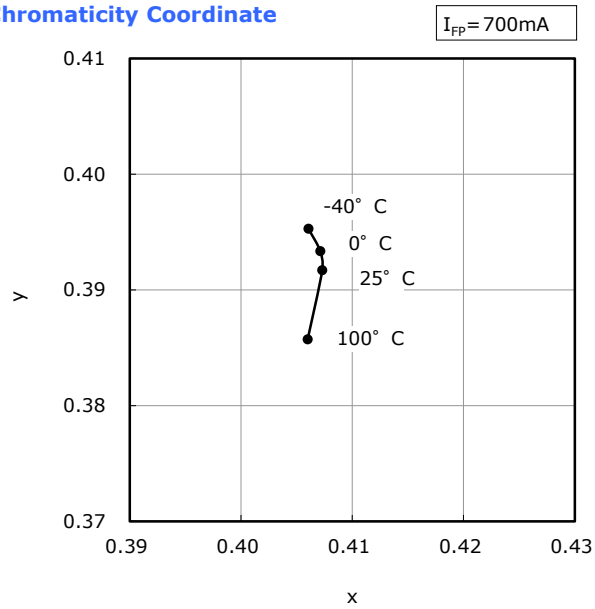

\* 本特性は演色性ランクR8000に対応しています。  
The graphs above show the characteristics for R8000 LEDs of this product.

FORWARD CURRENT CHARACTERISTICS / TEMPERATURE CHARACTERISTICS

\* 本特性は参考です。  
All characteristics shown are for reference only and are not guaranteed.

NVSL219C  
管理番号 No. STS-DA7-9744

順電流-色度 特性  
Forward Current vs Chromaticity Coordinate

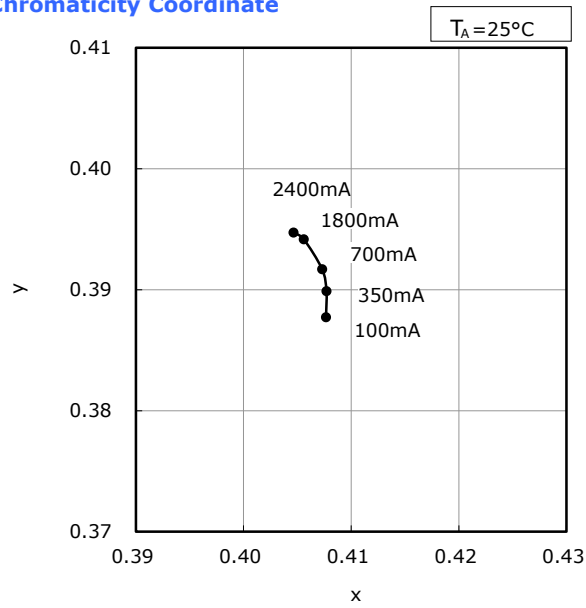

周囲温度-色度 特性  
Ambient Temperature vs Chromaticity Coordinate

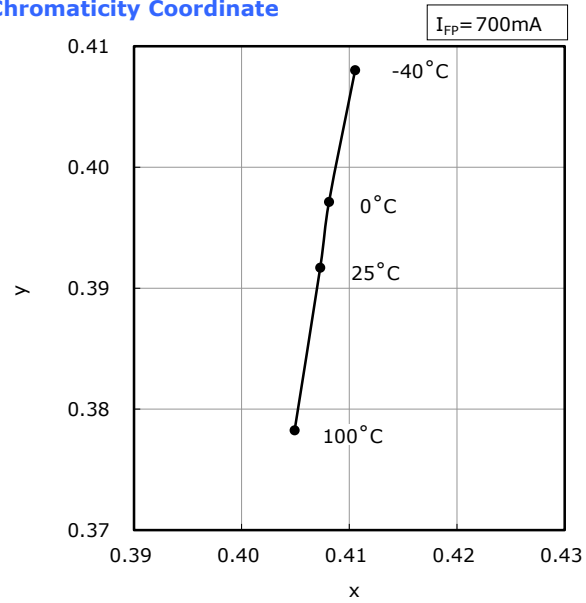

\* 本特性は演色性ランクR9050に対応しています。  
The graphs above show the characteristics for R9050 LEDs of this product.

## RELIABILITY

## (1) Tests and Results

| Test  | Reference Standard     | Test Conditions   | Test Duration | Failure Criteria # | Units Failed/Tested |
|---|------------------------|---|---------------|--------------------|---------------------|
| Resistance to Soldering Heat (Reflow Soldering) | JEITA ED-4701 300 301  | $T_{\text{slid}}=260^{\circ}\text{C}$ , 10sec, 2reflows, Precondition: $30^{\circ}\text{C}$ , 70%RH, 168hr  |               | #1                 | 0/22                |
| Solderability (Reflow Soldering)                | JEITA ED-4701 303 303A | $T_{\text{slid}}=245\pm 5^{\circ}\text{C}$ , 5sec, Lead-free Solder(Sn-3.0Ag-0.5Cu)   |               | #2                 | 0/22                |
| Temperature Cycle                               | JEITA ED-4701 100 105  | $-40^{\circ}\text{C}(30\text{min})\sim 25^{\circ}\text{C}(5\text{min})\sim 100^{\circ}\text{C}(30\text{min})\sim 25^{\circ}\text{C}(5\text{min})$ | 100cycles     | #1                 | 0/22                |
| Moisture Resistance (Cyclic)                    | JEITA ED-4701 200 203  | $25^{\circ}\text{C}\sim 65^{\circ}\text{C}\sim -10^{\circ}\text{C}$ , 90%RH, 24hr per cycle   | 10cycles      | #1                 | 0/22                |
| High Temperature Storage                        | JEITA ED-4701 200 201  | $T_{\text{A}}=100^{\circ}\text{C}$  | 1000hours     | #1                 | 0/22                |
| Temperature Humidity Storage                    | JEITA ED-4701 100 103  | $T_{\text{A}}=60^{\circ}\text{C}$ , RH=90%  | 1000hours     | #1                 | 0/22                |
| Low Temperature Storage                         | JEITA ED-4701 200 202  | $T_{\text{A}}=-40^{\circ}\text{C}$  | 1000hours     | #1                 | 0/22                |
| Room Temperature Operating Life                 |                        | $T_{\text{A}}=25^{\circ}\text{C}$ , $I_{\text{F}}=1000\text{mA}$<br>Test board: See NOTES below   | 1000hours     | #1                 | 0/22                |
| High Temperature Operating Life                 |                        | $T_{\text{A}}=100^{\circ}\text{C}$ , $I_{\text{F}}=400\text{mA}$<br>Test board: See NOTES below   | 1000hours     | #1                 | 0/22                |
| Temperature Humidity Operating Life             |                        | $60^{\circ}\text{C}$ , RH=90%, $I_{\text{F}}=700\text{mA}$<br>Test board: See NOTES below   | 500hours      | #1                 | 0/22                |
| Low Temperature Operating Life                  |                        | $T_{\text{A}}=-40^{\circ}\text{C}$ , $I_{\text{F}}=700\text{mA}$<br>Test board: See NOTES below   | 1000hours     | #1                 | 0/22                |
| Vibration                                       | JEITA ED-4701 400 403  | $200\text{m/s}^2$ , 100~2000~100Hz, 4cycles, 4min, each X, Y, Z   | 48minutes     | #1                 | 0/10                |
| Electrostatic Discharges                        | JEITA ED-4701 300 304  | HBM, 2kV, 1.5k $\Omega$ , 100pF, 3pulses, alternately positive or negative  |               | #1                 | 0/22                |

## NOTES:

- 1) Test board: FR4 board thickness=1.6mm, copper layer thickness=0.07mm,  $R_{\theta\text{JA}}\approx 30^{\circ}\text{C/W}$
- 2) Measurements are performed after allowing the LEDs to return to room temperature.

## (2) Failure Criteria

| Criteria # | Items                              | Conditions                  | Failure Criteria              |
|------------|------------------------------------|-----------------------------|-------------------------------|
| #1         | Forward Voltage( $V_{\text{F}}$ )  | $I_{\text{F}}=700\text{mA}$ | >Initial value $\times 1.1$   |
|            | Luminous Flux( $\Phi_{\text{V}}$ ) | $I_{\text{F}}=700\text{mA}$ | <Initial value $\times 0.7$   |
| #2         | Solderability                      | -                           | Less than 95% solder coverage |

## CAUTIONS

### (1) Storage

| Conditions |                             | Temperature                | Humidity              | Time                             |
|------------|-----------------------------|----------------------------|-----------------------|----------------------------------|
| Storage    | Before Opening Aluminum Bag | $\leq 30^{\circ}\text{C}$  | $\leq 90\% \text{RH}$ | Within 1 Year from Delivery Date |
|            | After Opening Aluminum Bag  | $\leq 30^{\circ}\text{C}$  | $\leq 70\% \text{RH}$ | $\leq 168 \text{hours}$          |
| Baking     |                             | $65 \pm 5^{\circ}\text{C}$ | -                     | $\geq 24 \text{hours}$           |

- The storage/packaging requirements for this LED are comparable to JEDEC Moisture Sensitivity Level (MSL) 3 or equivalent. Nichia used IPC/JEDEC STD-020 as a reference to rate the MSL of this LED.
- This LED uses a package that could absorb moisture; if the package absorbs moisture and is exposed to heat during soldering, it may cause the moisture to vaporize and the package to expand and the resulting pressure may cause internal delamination. This may cause the optical characteristics to degrade. To minimize moisture absorption in storage/transit, moisture-proof aluminum bags are used for the LEDs with a silica gel packet to absorb any air moisture in the bag. The silica gel beads turn blue to red as they absorb moisture.
- Once the moisture-proof aluminum bag is open, ensure that the LED is soldered to a PCB within the range of the conditions above. To store any remaining unused LEDs, use a hermetically sealed container with silica gel desiccants. Nichia recommends placing them back to the original moisture-proof bag and reseal it.
- If the "After Opening" storage time has been exceeded or any pink silica gel beads are found, ensure that the LED are baked before use. Baking should only be done once.
- This LED has gold-plated electrodes. If the LEDs are exposed to a corrosive environment, it may cause the plated surface to tarnish causing issues (i.e. solderability). Ensure that when storing LEDs, a hermetically sealed container is used. Nichia recommends placing them back to the original moisture-proof bag and reseal it.
- To prevent substances/gases from affecting the plated surface, ensure that the parts/materials used with the LEDs in the same assembly/system do not contain sulfur (e.g. gasket/seal, adhesive, etc.). If the plating is contaminated, it may cause issues (e.g. electric connection failures). If a gasket/seal is used, silicone rubber gaskets/seals are recommended; ensure that this use of silicone does not result in issues (e.g. electrical connection failures) caused by low molecular weight volatile siloxane.
- To avoid condensation, the LEDs must not be stored in areas where temperature and humidity fluctuate greatly.
- Do not store the LEDs in a dusty environment.
- Do not expose the LEDs to direct sunlight and/or an environment over a long period of time where the temperature is higher than normal room temperature.

### (2) Directions for Use

- The circuit must be designed to ensure that the Absolute Maximum Ratings are not exceeded for each LED. The LEDs should be operated at a constant current per LED. In the case of operating at a constant voltage, Circuit B is recommended. If Circuit A is used, it may cause the currents flowing through the LEDs to vary due to the variation in the forward voltage characteristics of the LEDs on the circuit.

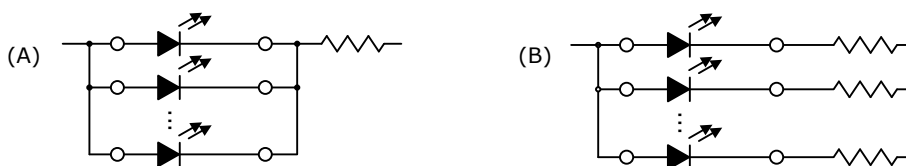

- This LED is designed to be operated at a forward current. Ensure that no voltage is applied to the LED in the forward/reverse direction while the LED is off. If the LEDs are used in an environment where reverse voltages are applied to the LED continuously, it may cause electrochemical migration to occur causing the LED to be damaged. When not in use for a long period of time, the system's power should be turned off to ensure that there are no issues/damage.
- To stabilize the LED characteristics while in use, Nichia recommends that the LEDs are operated at currents  $\geq 10\%$  of the sorting current.
- Ensure that transient excessive voltages (e.g. lighting surge) are not applied to the LEDs.
- If the LEDs are used for outdoor applications, ensure that necessary measures are taken (e.g. protecting the LEDs from water/salt damage and high humidity).

### (3) Handling Precautions

- Do not handle the LEDs with bare hands as it will contaminate the LED surface and may affect the optical characteristics: it might cause the LED to be deformed and/or the bump to break, which will cause the LED not to illuminate.
- Ensure that when handling the LEDs with tweezers, excessive force is not applied to the LED. Otherwise, it may cause damage to the resin (e.g. cut, scratch, chip, crack, delamination and deformation) and the internal connection to fail causing a catastrophic failure (i.e. the LED not to illuminate).
- Dropping may cause damage to the LED (e.g. deformation).
- Do not stack assembled PCBs together. Otherwise, it may cause damage to the resin (e.g. cut, scratch, chip, crack, delamination and deformation) and the internal connection to fail causing a catastrophic failure (i.e. the LED not to illuminate).

### (4) Design Consideration

- If the LEDs are soldered to a PCB and the PCB assembly is bent (e.g. PCB depaneling process), it may cause the LED package to break. The PCB layout should be designed to minimize the mechanical stress on the LEDs when the PCB assembly is bent/warped.
- The amount of mechanical stress exerted on the LED from depaneling may vary depending on the LED position/orientation on the PCB assembly (e.g. especially in areas near V-groove scores). The PCB layout should be designed to minimize the mechanical stress on the LEDs when the PCB is separated into individual PCB assemblies.
- To separate a PCB populated with the LEDs, use a specially designed tool. Do not break the PCB by hand.
- If an aluminum-core PCB is used to operate the LEDs, it may cause thermal stress during operation causing damage to the solder joints (e.g. crack). Ensure that sufficient verification is performed prior to use.
- Volatile organic compounds that have been released from materials present around the LEDs (e.g. housing, packing, adhesive, secondary lens, lens cover, etc.) may penetrate LED lens and/or internal pre-coating resin. If the LEDs are being used in a hermetically sealed environment, these volatile compounds can discolor after being exposed to heat and/or photon energy and it may greatly reduce the LED light output and/or cause a color shift. In this case, ventilating the environment may improve the reduction in light output and/or color shift. Perform a light-up test of the chosen application for optical evaluation to ensure that there are no issues, especially if the LEDs are planned to be used in a hermetically sealed environment.

### (5) Electrostatic Discharge (ESD)

- This LED is sensitive to transient excessive voltages (e.g. ESD, lightning surge). If this excessive voltage occurs in the circuit, it may cause the LED to be damaged causing issues (e.g. the LED to become dimmer or not to illuminate [i.e. catastrophic failure]). Ensure that when handling the LEDs, necessary measures are taken to protect them from an ESD discharge. The following examples are recommended measures to eliminate the charge:
  - Grounded wrist strap, ESD footwear, clothes, and floors
  - Grounded workstation equipment and tools
  - ESD table/shelf mat made of conductive materials
- Ensure that all necessary measures are taken to prevent the LEDs from being exposed to transient excessive voltages (e.g. ESD, lightning surge):
  - tools, jigs, and machines that are used are properly grounded
  - appropriate ESD materials/equipment are used in the work area
  - the system/assembly is designed to provide ESD protection for the LEDs
- If the tool/equipment used is an insulator (e.g. glass cover, plastic, etc.), ensure that necessary measures have been taken to protect the LED from transient excessive voltages (e.g. ESD). The following examples are recommended measures to eliminate the charge:
  - Dissipating static charge with conductive materials
  - Preventing charge generation with moisture
  - Neutralizing the charge with ionizers
- To detect if an LED was damaged by transient excess voltages (i.e. an ESD event during the system's assembly process), perform a characteristics inspection (e.g. forward voltage measurement, light-up test) at low current ( $\leq 1\text{mA}$ ).
- Failure Criteria:  $V_F < 2.0\text{V}$  at  $I_F = 0.5\text{mA}$   
 If the LED is damaged by transient excess voltages (e.g. ESD), it will cause:
  - the Forward Voltage ( $V_F$ ) to decrease
  - the LED not to illuminate at a low current

## (6) Thermal Management

- The Absolute Maximum Junction Temperature ( $T_J$ ) must not be exceeded under any circumstances. The increase in the temperature of an LED while in operation may vary depending on the PCB thermal resistance and the density of LEDs on the PCB assembly. Ensure that when using the LEDs for the chosen application, heat is not concentrated in an area and properly managed in the system/assembly.
- The operating current should be determined by considering the temperature conditions surrounding the LED (i.e.  $T_A$ ). Ensure that when operating the LED, proper measures are taken to dissipate the heat.
- The following two equations can be used to calculate the LED junction temperature:

$$1) T_J = T_A + R_{\theta JA} \cdot W \quad 2) T_J = T_S + R_{\theta JS} \cdot W$$

\* $T_J$ =LED Junction Temperature: °C

$T_A$ =Ambient Temperature: °C

$T_S$ =Soldering Temperature (Cathode Side): °C

$R_{\theta JA}$ =Thermal Resistance from Junction to Ambient: °C/W

$R_{\theta JS}$ =Thermal Resistance from Junction to  $T_S$  Measurement Point: °C/W

$W$ =Input Power( $I_F \times V_F$ ): W

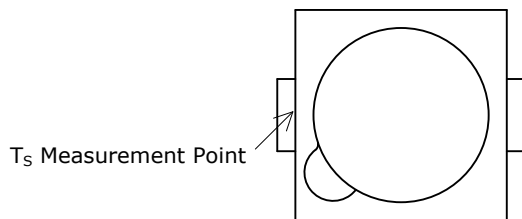

## (7) Cleaning

- Do not clean the LEDs with water, benzine and/or thinner.
- To clean the LEDs, use isopropyl alcohol (IPA). If another solvent is used, it may cause the LED package/resin to be damaged causing issues; ensure that sufficient verification is performed prior to use. Additionally, ensure that the solvent being used does not cause any other issues (e.g. CFC-based solvents are heavily regulated).
- If an LED is contaminated (e.g. dust/dirt), use a cloth soaked with isopropyl alcohol (IPA). Ensure that the cloth is firmly squeezed before wiping the LED.
- Do not clean the LEDs with an ultrasonic cleaner. If cleaning must be done, ensure that sufficient verification is performed by using a finished assembly with LEDs to determine cleaning conditions (e.g. ultrasonic power, LED position on the PCB assembly) that do not cause an issue.

## (8) Eye Safety

- There may be two important international specifications that should be noted for safe use of the LEDs: IEC 62471:2006 Photobiological safety of lamps and lamp systems and IEC 60825-1:2001 (i.e. Edition 1.2) Safety of Laser Products - Part 1: Equipment Classification and Requirements. Ensure that when using the LEDs, there are no issues with the following points:
  - LEDs have been removed from the scope of IEC 60825-1 since IEC 60825-1:2007 (i.e. Edition 2.0) was published. However, depending on the country/region, there are cases where the requirements of the IEC 60825-1:2001 specifications or equivalent must be adhered to.
  - LEDs have been included in the scope of IEC 62471:2006 since the release of the specification in 2006.
  - Most Nichia LEDs will be classified as the Exempt Group or Risk Group 1 according to IEC 62471:2006. However, in the case of high-power LEDs containing blue wavelengths in the emission spectrum, there are LEDs that will be classified as Risk Group 2 depending on the characteristics (e.g. radiation flux, emission spectrum, directivity, etc.)
  - If the LED is used in a manner that produces an increased output or with an optic to collimate the light from the LED, it may cause damage to the human eye.
- If an LED is operated in a manner that emits a flashing light, it may cause health issues (e.g. visual stimuli causing eye discomfort). The system should be designed to ensure that there are no harmful effects on the human body.

## (9) Miscellaneous

- Nichia warrants that the discrete LEDs will meet the requirements/criteria as detailed in the Reliability section within this specification. If the LEDs are used under conditions/environments deviating from or inconsistent with those described in this specification, the resulting damage and/or injuries will not be covered by this warranty.
- Nichia warrants that the discrete LEDs manufactured and/or supplied by Nichia will meet the requirements/criteria as detailed in the Reliability section within this specification; it is the customer's responsibility to perform sufficient verification prior to use to ensure that the lifetime and other quality characteristics required for the intended use are met.
- The applicable warranty period is one year from the date that the LED is delivered. In the case of any incident that appears to be in breach of this warranty, the local Nichia sales representative should be notified to discuss instructions on how to proceed while ensuring that the LED in question is not disassembled or removed from the PCB if it has been attached to the PCB. If a breach of this warranty is proved, Nichia will provide the replacement for the non-conforming LED or an equivalent item at Nichia's discretion. FOREGOING ARE THE EXCLUSIVE REMEDIES AVAILABLE TO THE CUSTOMER IN RESPECT OF THE BREACH OF THE WARRANTY CONTAINED HEREIN, AND IN NO EVENT SHALL NICHIA BE RESPONSIBLE FOR ANY INDIRECT, INCIDENTAL OR CONSEQUENTIAL LOSSES AND/OR EXPENSES (INCLUDING LOSS OF PROFIT) THAT MAY BE SUFFERED BY THE CUSTOMER ARISING OUT OF A BREACH OF THE WARRANTY.
- NICHIA DISCLAIMS ALL OTHER WARRANTIES, EXPRESS OR IMPLIED, INCLUDING THE IMPLIED WARRANTIES OF MERCHANTABILITY AND FITNESS FOR A PARTICULAR PURPOSE.
- This LED is intended to be used for general lighting, household appliances, electronic devices (e.g. mobile communication devices); it is not designed or manufactured for use in applications that require safety critical functions (e.g. aircraft, automobiles, combustion equipment, life support systems, nuclear reactor control system, safety devices, spacecraft, submarine repeaters, traffic control equipment, trains, vessels, etc.). If the LEDs are planned to be used for these applications, unless otherwise detailed in the specification, Nichia will neither guarantee that the LED is fit for that purpose nor be responsible for any resulting property damage, injuries and/or loss of life/health. This LED does not comply with ISO/TS 16949 and is not intended for automotive applications.
- The customer will not reverse engineer, disassemble or otherwise attempt to extract knowledge/design information from the LED.
- All copyrights and other intellectual property rights in this specification in any form are reserved by Nichia or the right holders who have granted Nichia permission to use the content. Without prior written permission from Nichia, no part of this specification may be reproduced in any form or by any means.
- Both the customer and Nichia will agree on the official specifications for the supplied LEDs before any programs are officially launched. Without this agreement in writing (i.e. Customer Specific Specification), changes to the content of this specification may occur without notice (e.g. changes to the foregoing specifications and appearance, discontinuation of the LEDs, etc.).